

027057
02693: Enc. juntos

CATALOGADO

01924



INSTITUTO DE PLANEAMIENTO REGIONAL Y URBANO
FACULTAD DE CIENCIAS MATEMATICAS
UNIVERSIDAD NACIONAL DEL LITORAL

F. 3113

0
F. 3113
511 F15
I-II-III

- RECTOR DE LA UNIVERSIDAD NACIONAL DEL LITORAL
- INGENIERO CORTES PLA
- DECANO DE LA FACULTAD DE CIENCIAS MATEMATICAS
- ARQUITECTO MARIO SEGOVIA MAYER
- DIRECTOR DEL INSTITUTO DE PLANEAMIENTO REGIONAL Y URBANO
- ARQUITECTO JORGE ENRIQUE HARDOY

ANALISIS SECTORIAL DE LA
PROVINCIA DE ENTRE RIOS

TOMO I

GRAFICOS

Instituto de Planeamiento Regional y
Urbano de la Universidad Nacional
del Litoral

ANALISIS DEMONSTRATIO

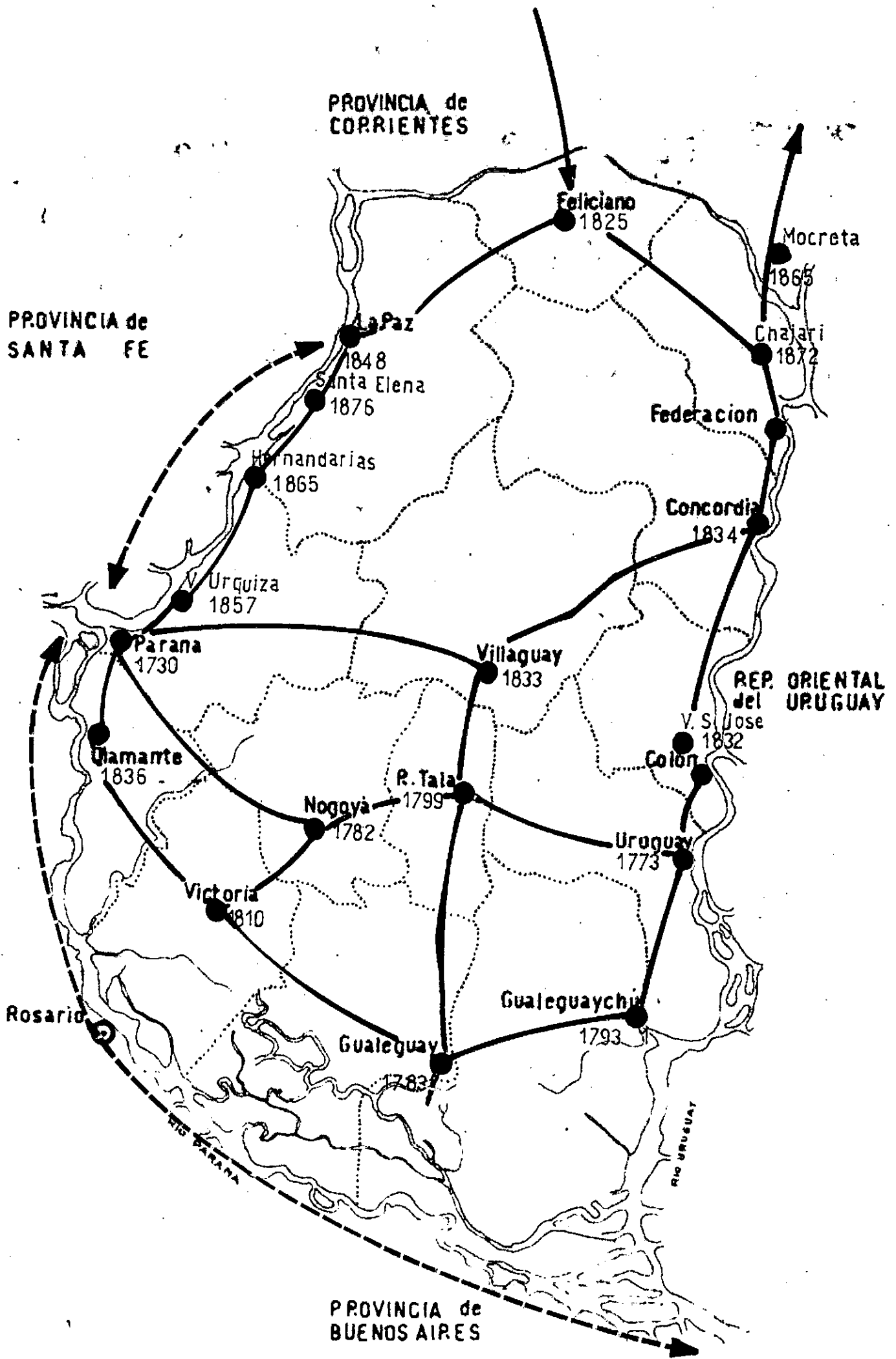

FUNDACION DE CIUDADES Y COMUNICACIONES 1730-1869

— RED HIPOTETICA DE COMUNICACIONES

— NAVEGACION

G2

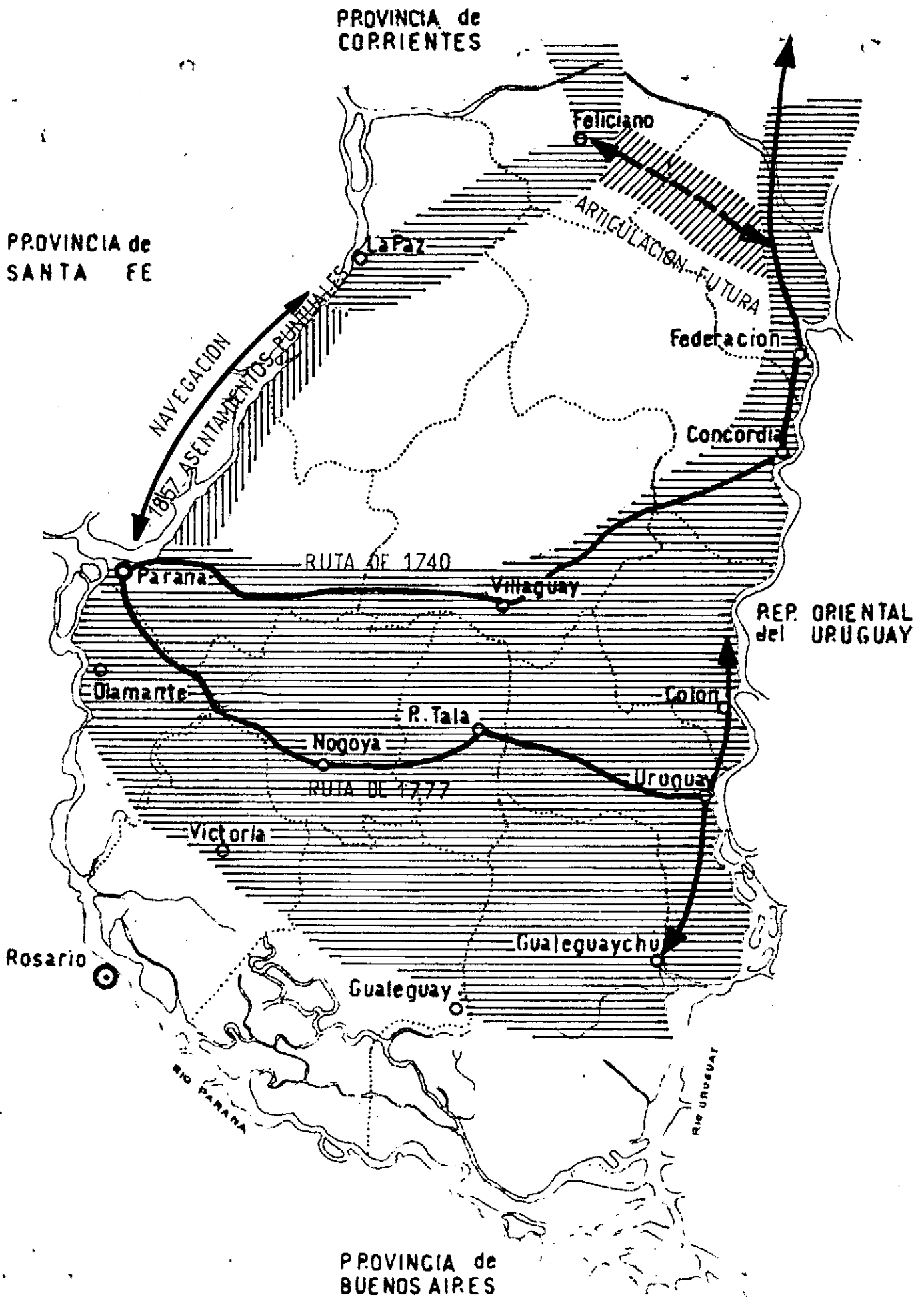

ZONAS DEL DESARROLLO GEOGRAFICO

G3

TOTAL DE POBLACION	1848 CENSO PCIAL.	1857 CENSO NAC.	1863 ESTIMACION NOUSSY
SECCION ORIENTAL	29.045	44.098	62.000
SECCION OCCIDENTAL	18.629	38.198	45.000
TOTAL	47.674	82.296	107.000

PROVINCIA de
CORRIENTES

PROVINCIA de
SANTA FE

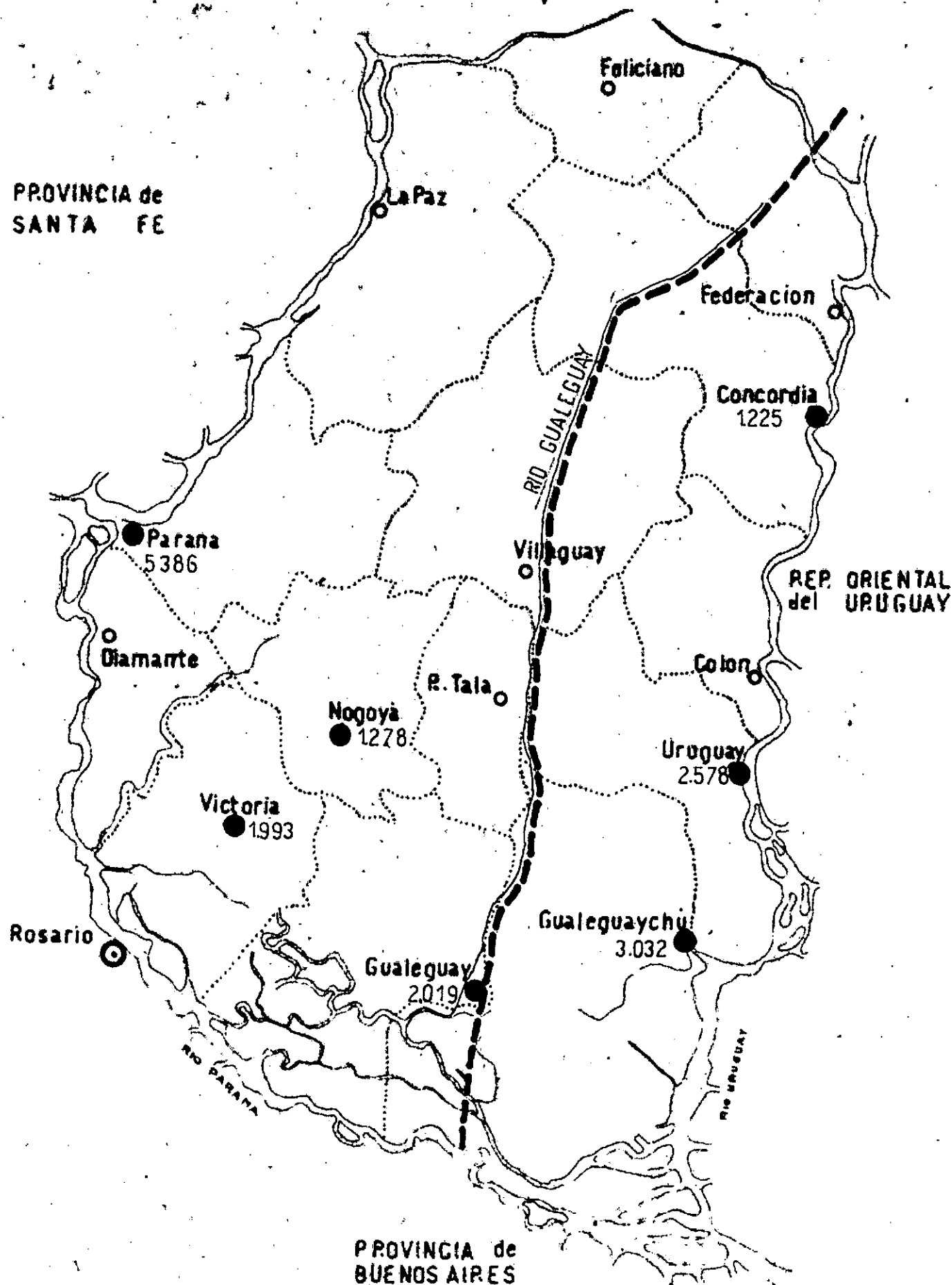

POBLACION SEGUN LOS CENSOS 1848 - 1857 y 1863

--- LIMITE ENTRE SECCION OCCIDENTAL Y ORIENTAL

● POBLACION URBANA CENSO 1848

G4

20 10 0

PROVINCIA de
CORRIENTES

PROVINCIA de
SANTA FE

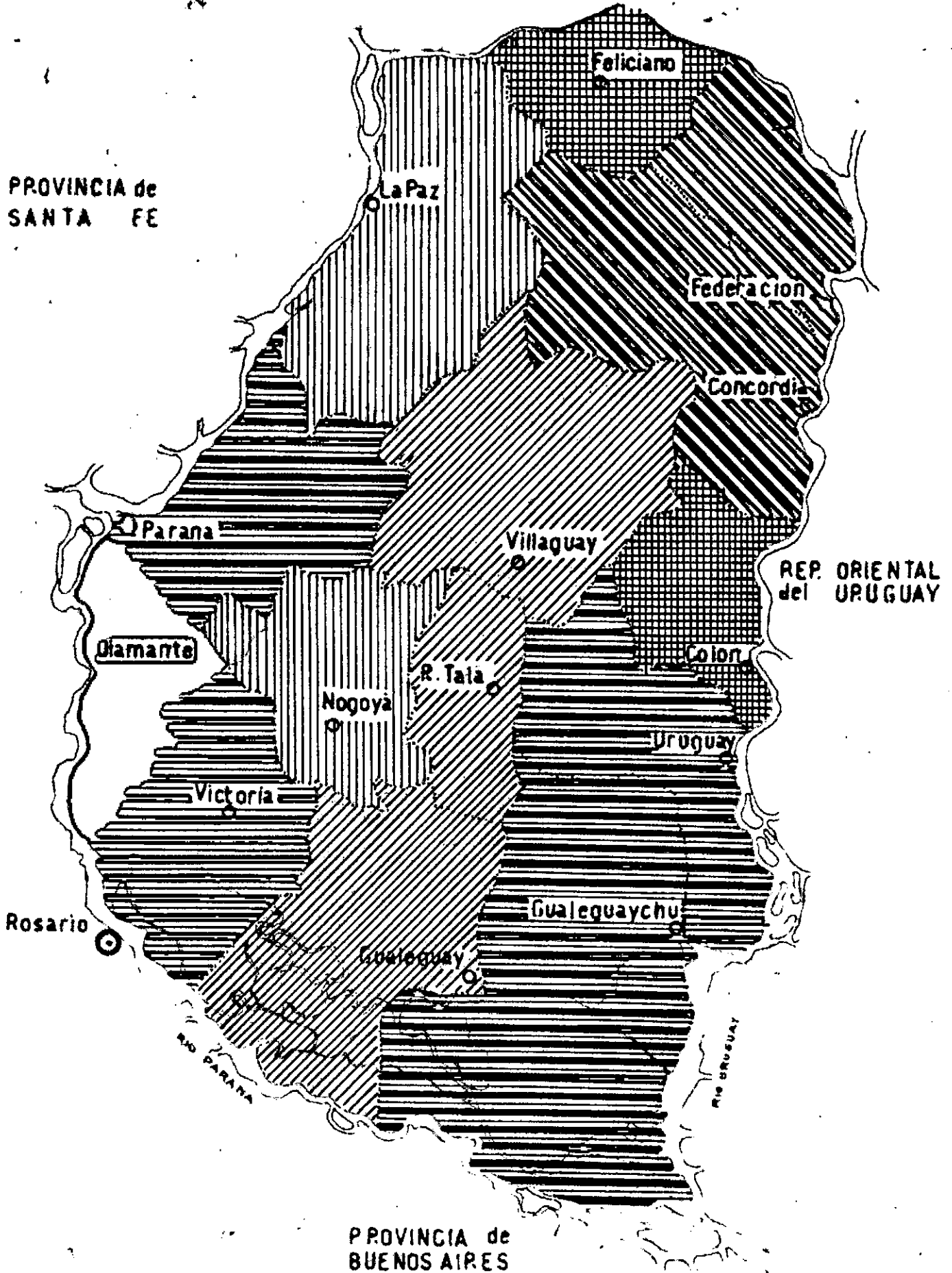

PROVINCIA de
BUENOS AIRES

TASA DE CRECIMIENTO DE LA POBLACION RURAL

TASAS DE CRECIMIENTO POR DEPARTAMENTO 1947 1960

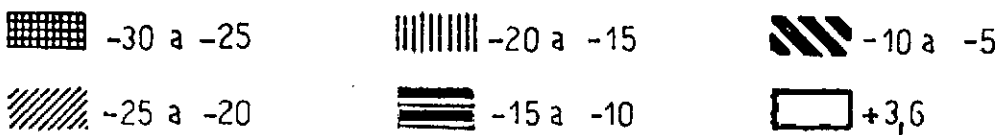

G5

50 20 10 0

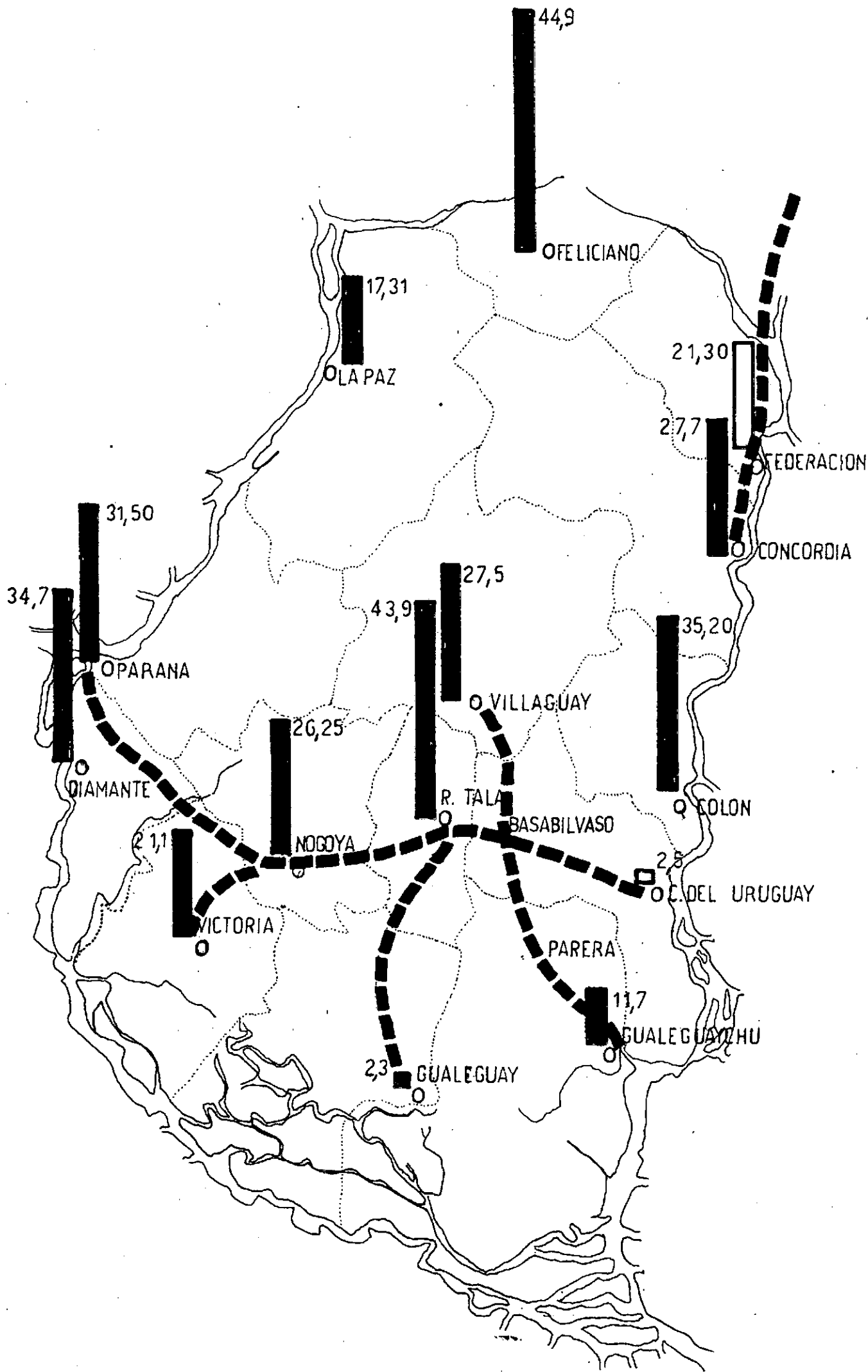

TASA CRECIM. URBANO F.F.C.C. CONSTRUIDOS 1869 1895

■ TASA POSITIVA

--- F.F.C.C.

□ TASA, NEGATIVA

GG

0 10 20 30 40

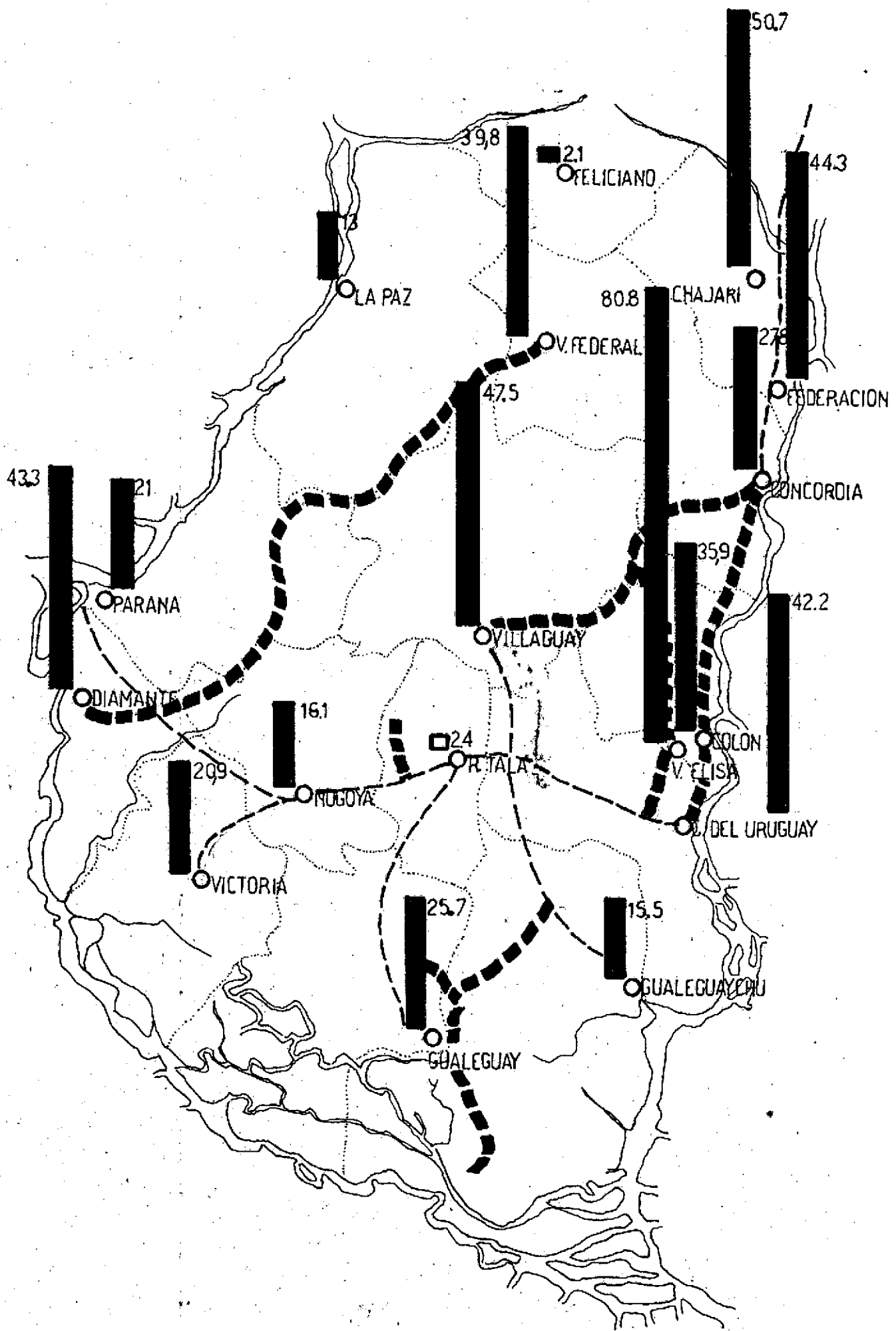

TASA CRECIM. URBANO / F.F.C.C. CONSTRUIDOS 1895/1914

■ TASA POSITIVA

--- E.F.C.C. 1895/1914

□ TASA NEGATIVA

— E.F.C.C. PERIODO ANTERIOR

G7

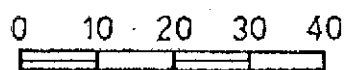

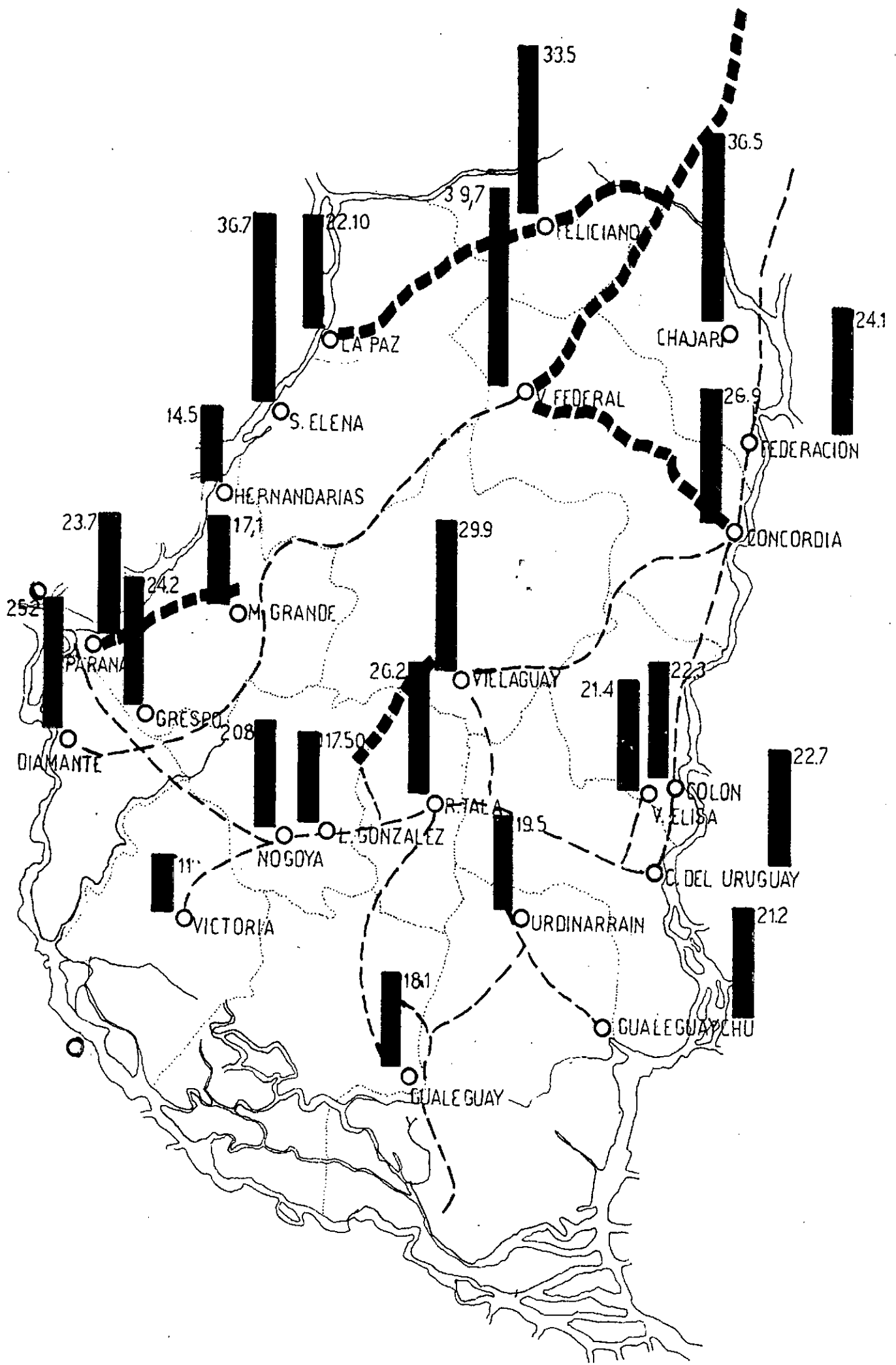

TASA CRECIM. URBANO F.F.C.C. CONSTRUIDOS 1914 1947

■ TASA POSITIVA

--- F.F.C.C. 1914 1947

□ TASA NEGATIVA

— F.F.C.C. PERIODOS ANTERIORES

GG

0 10 20 30 40

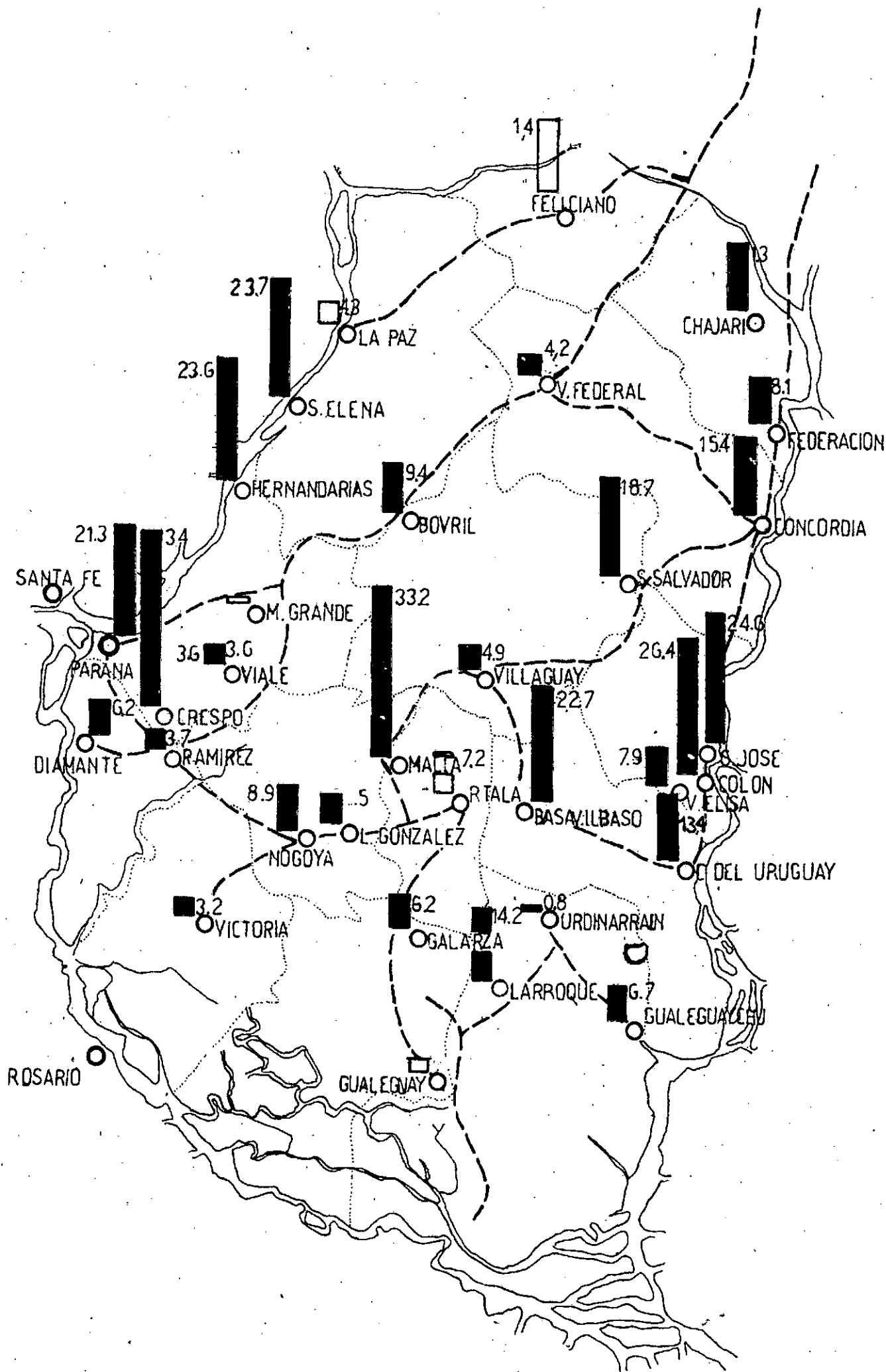

TASA DE CRECIMIENTO URBANO 1947/1960

■ TASA POSITIVA

□ TASA NEGATIVA

----- F.F.C.C. PERIODOS ANTERIORES

G9

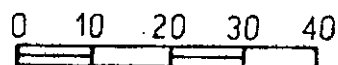

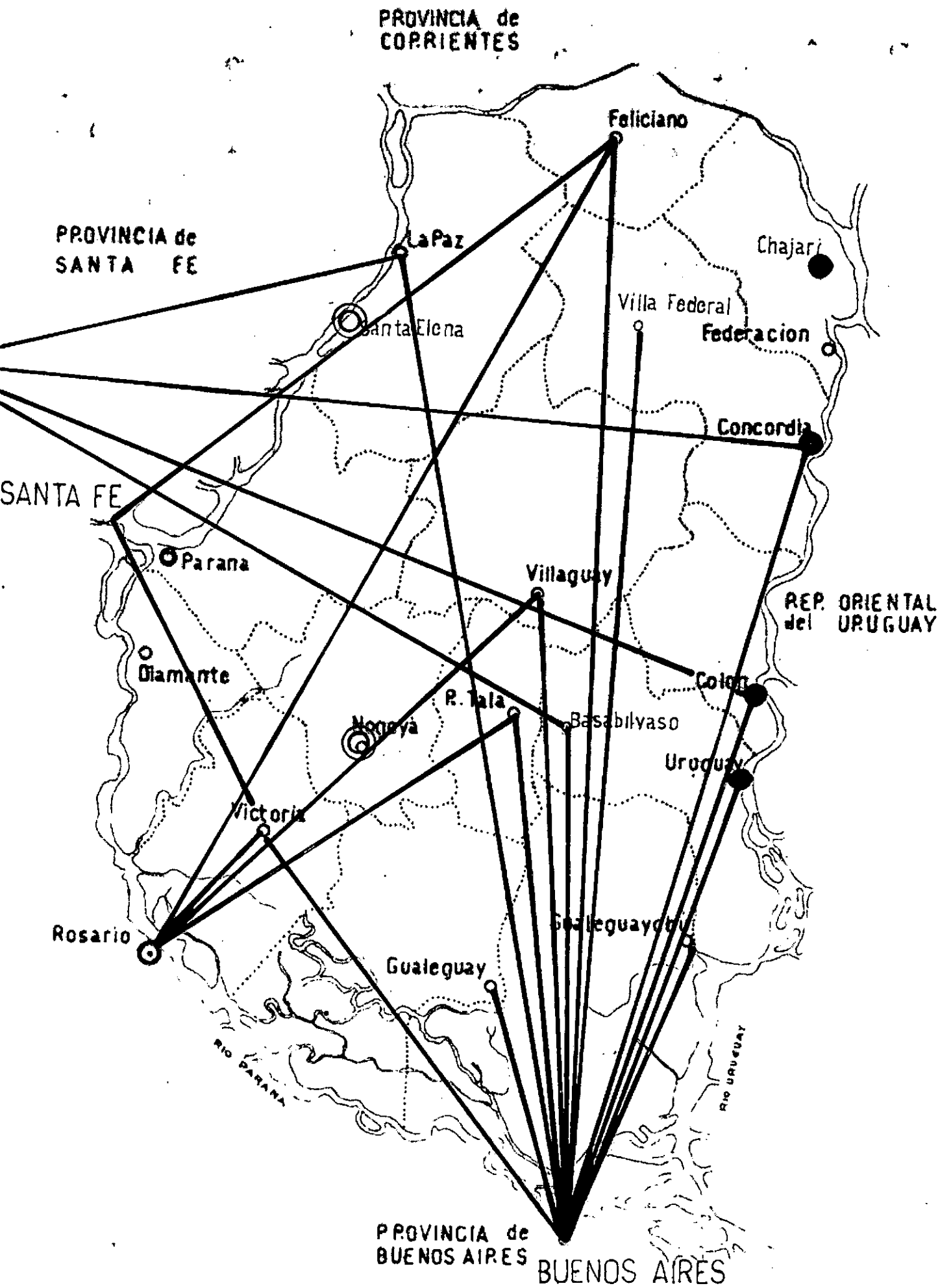

MIGRACION

- DIRECCION EMIGRACION
- CIUDAD CON INMIGRACION RURAL
- ◎ CIUDAD SIN EMIGRACION E INMIGRACION

G 10

GRAFICO N° 11



GRAFICO N° 12



GRAFICO Nº 13

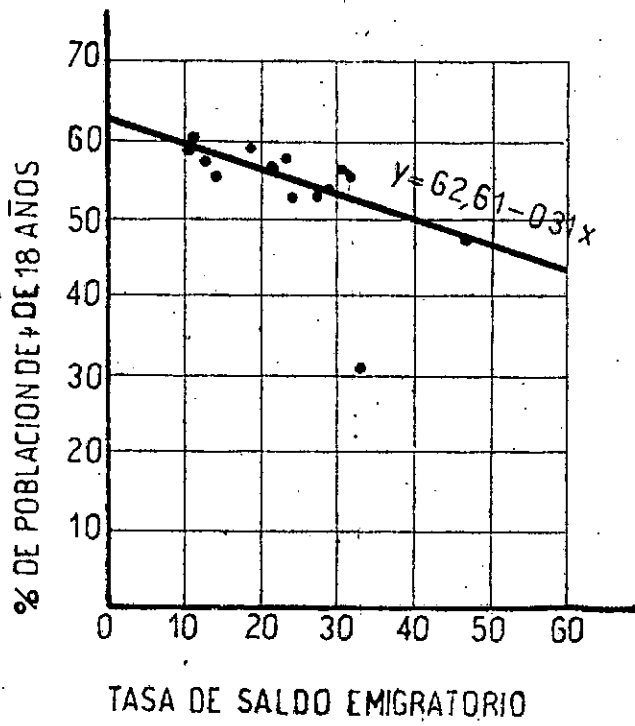

GRAFICO Nº 14

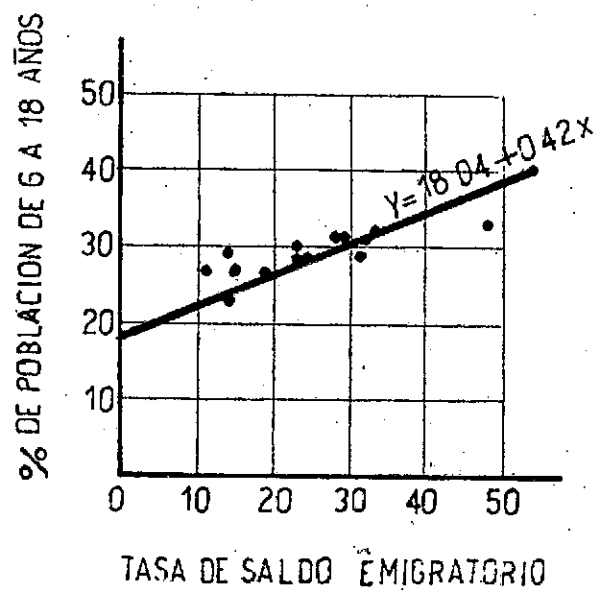

GRAFICO N° 15

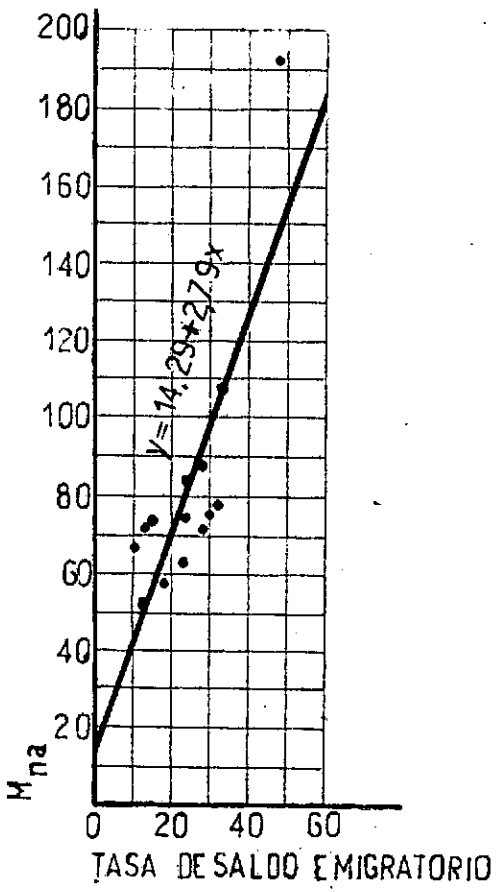

GRAFICO N° 16

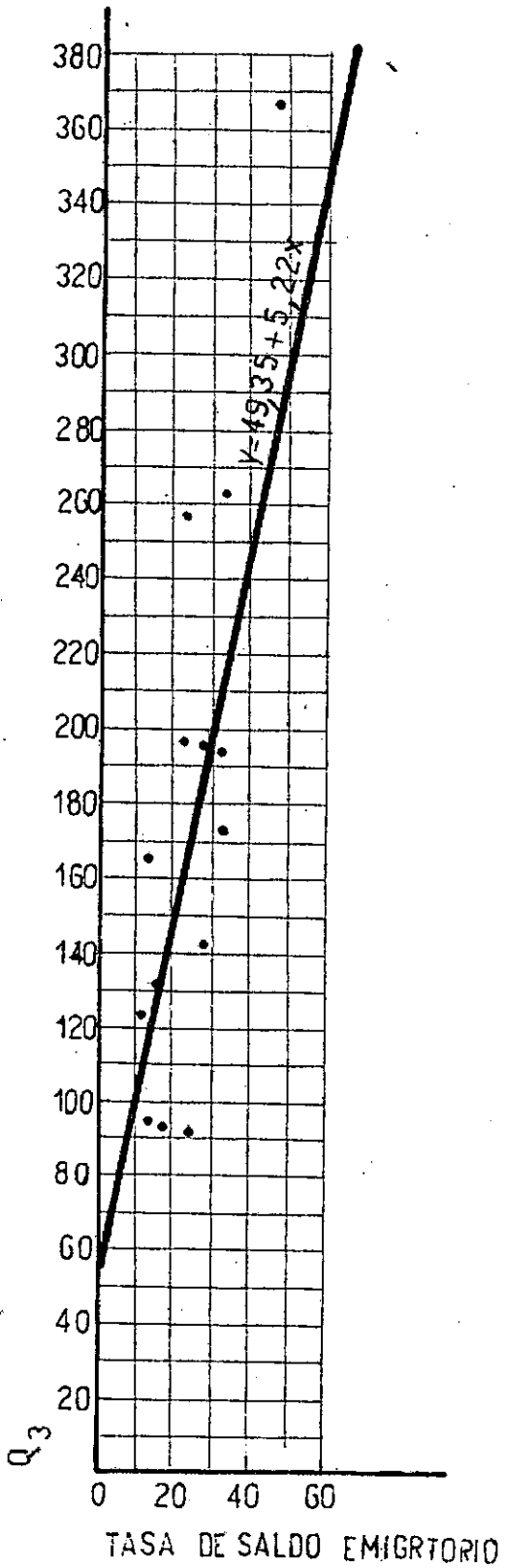

GRAFICO N° 17

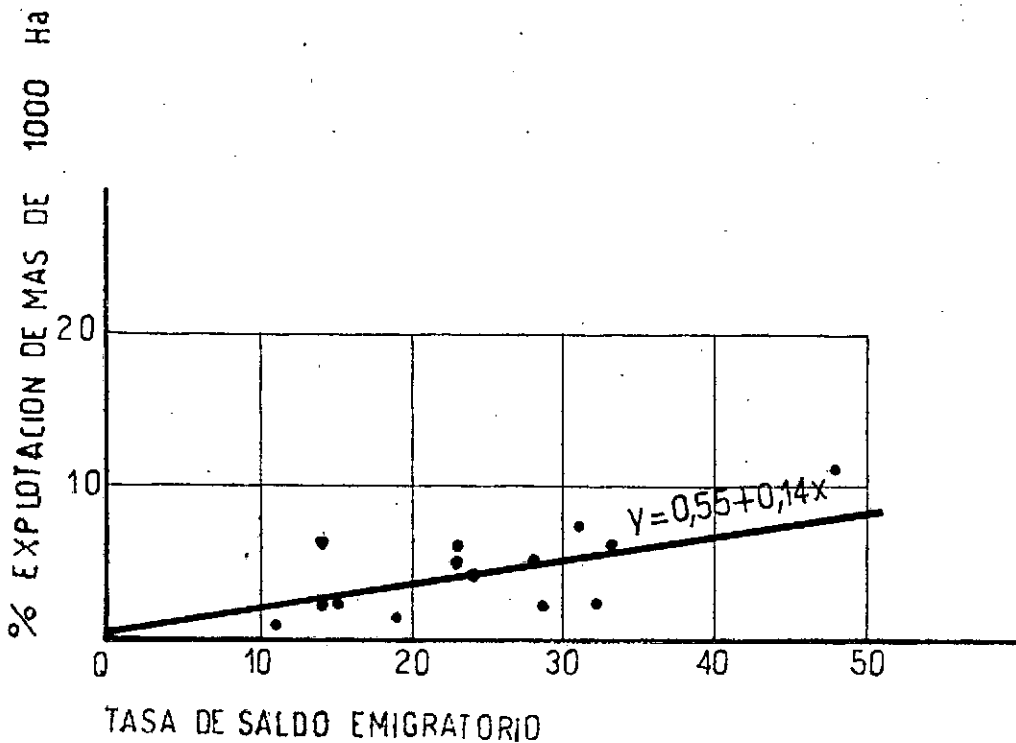

GRAFICO N° 18

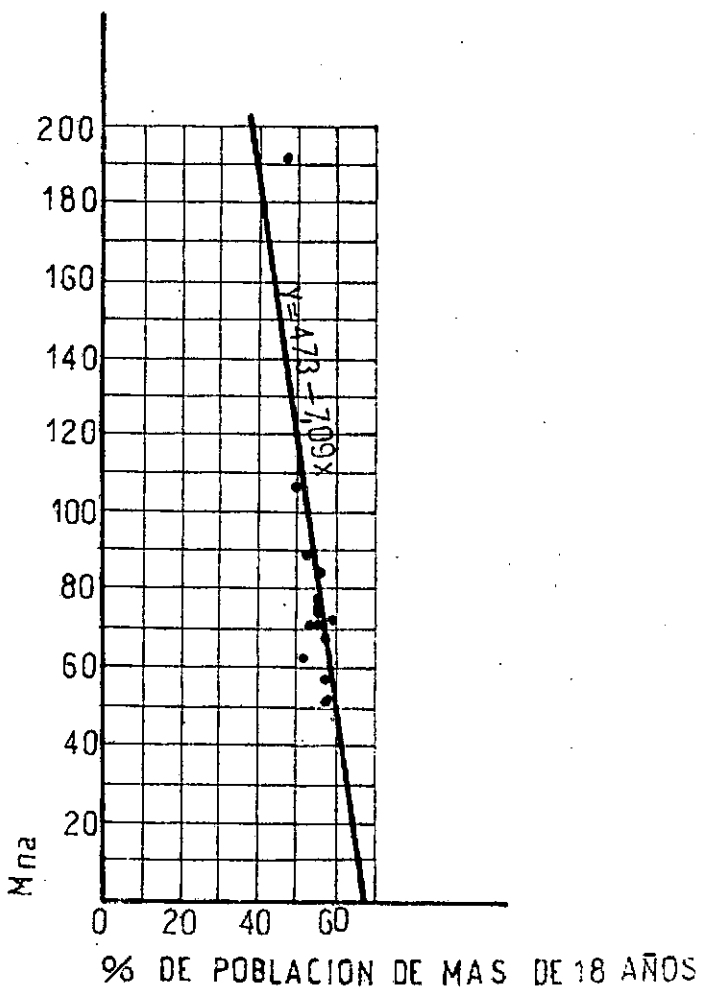

PROVINCIA DE
CORRIENTES

PROVINCIA DE
SANTA FE

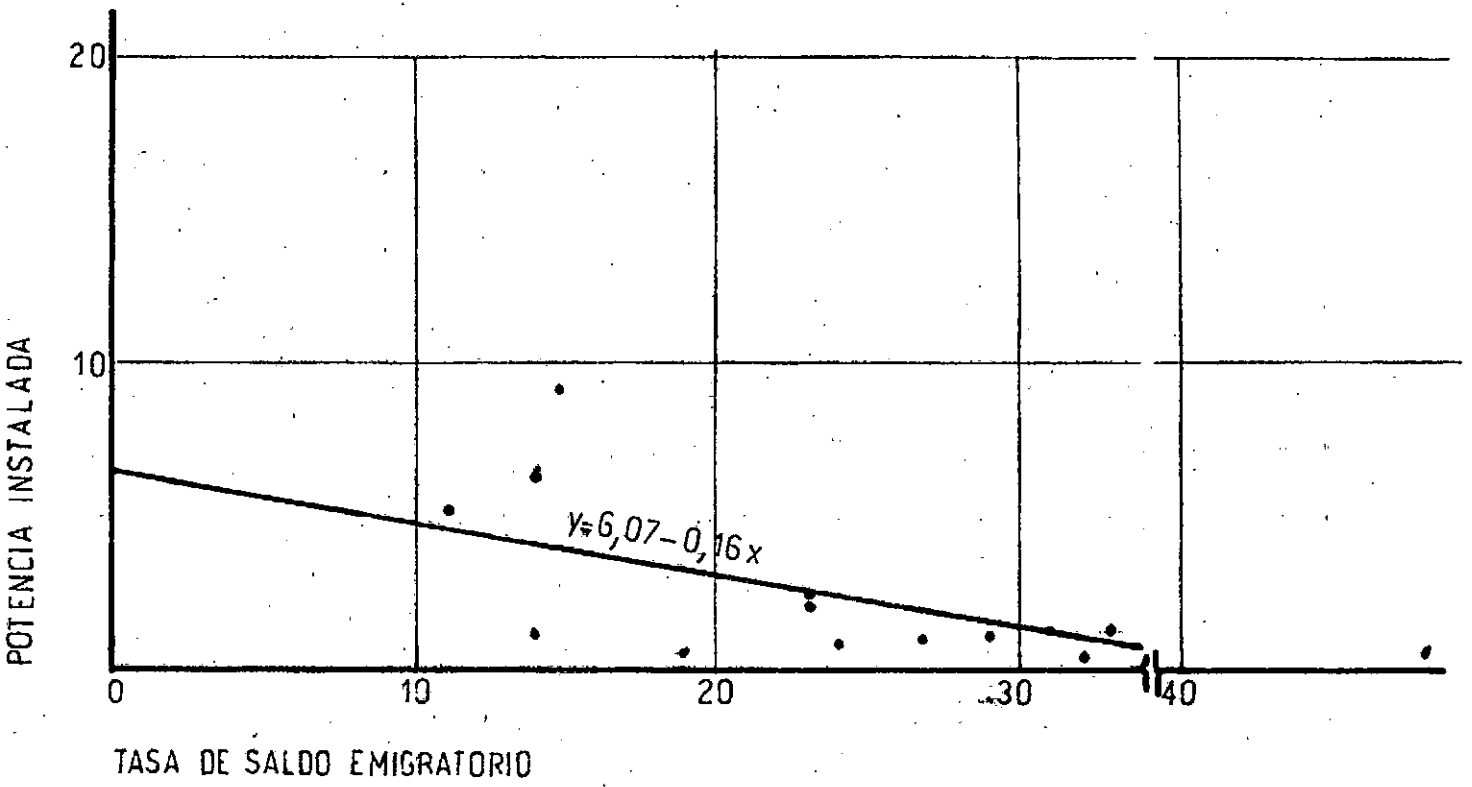
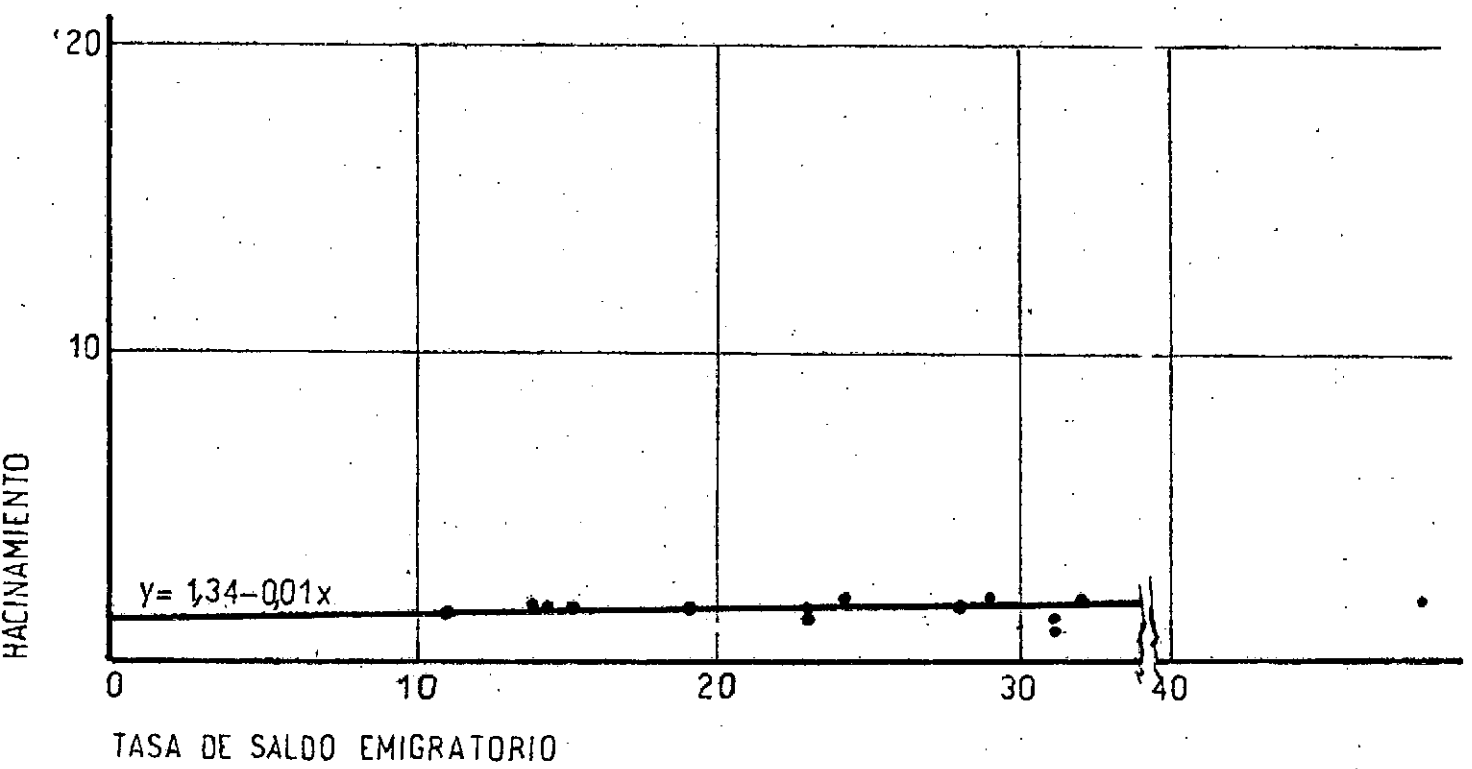
SANTA FE

PARANA

LA PAZ

LA PAZ

RACIUN

Salto

CONCORDIA

VILLAGUAY

DIAMANTE

DIAMANTE

NOGOYA

VICTORIA

ROSARIO

MAJIA

R TALA

SAUCE

SAUCE

MEDANOS

GUALEGUAY

GUALEGUAYCHO

COLON

C DEL URUGUAY

F. Bentos

N. Palmira

Baradero

Ramallo

S. Nicolás

TASA DE MASCULINIDAD POR DISTRITO varones c/100 mujeres

100

MENOS DE 100

100 a 105

105 a 110

MAS DE 110

G 20

FECHA:
ESCALA: 1:100,000

KM 0

5

Scale bar markings from 0 to 5 km.

REP. ORIENTAL
DEL URUGUAY

Paysandú

PROVINCIA DE
CORRIENTES

PROVINCIA DE
SANTA FE

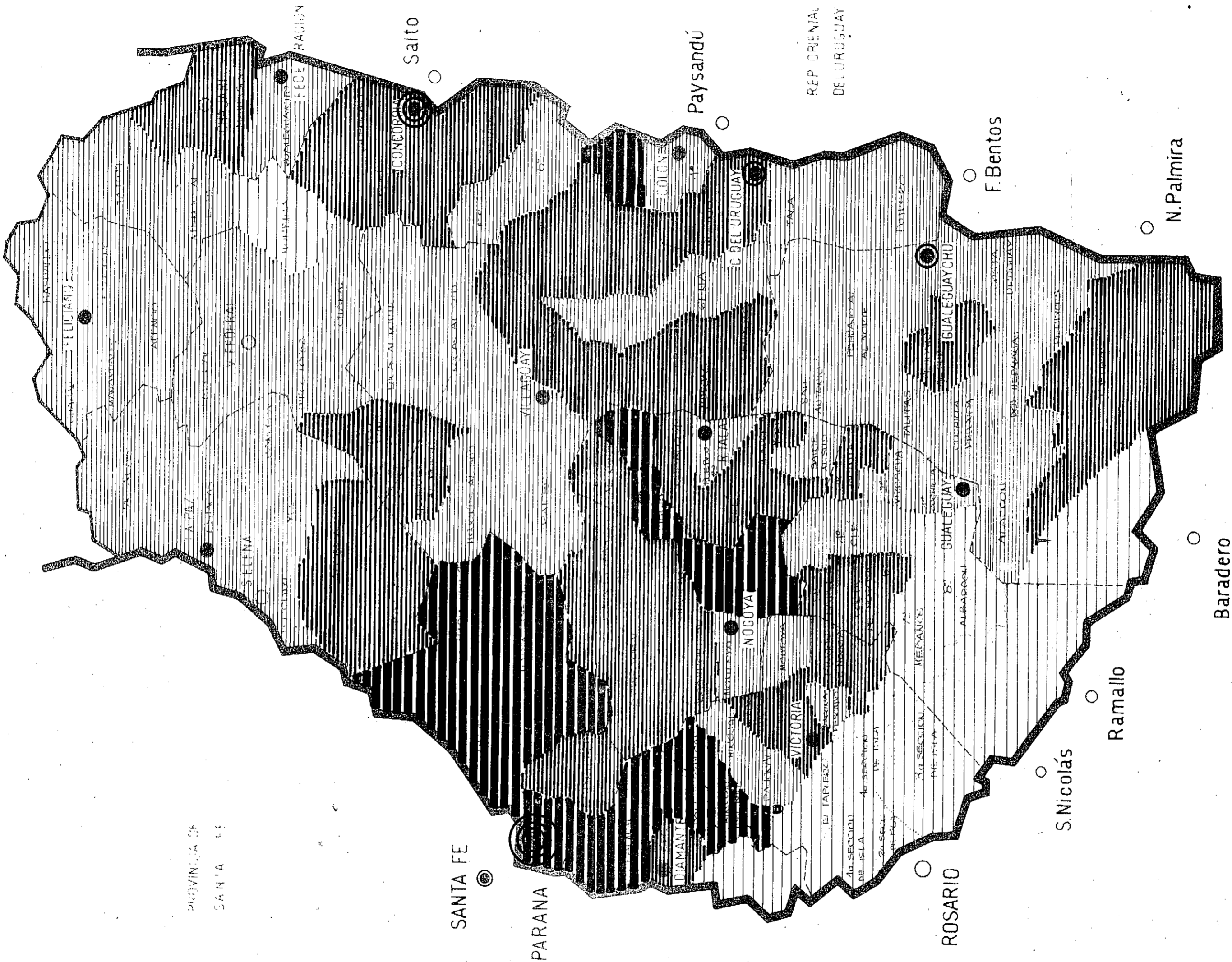

KM 0 50

DENSIDAD URBANA

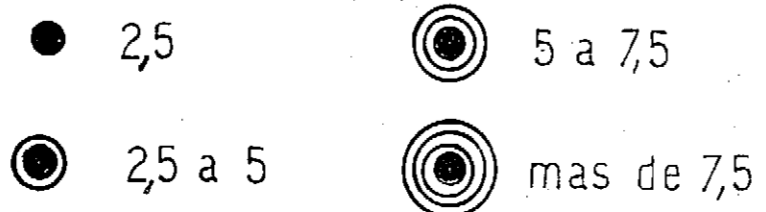

DENSIDAD POR DISTRITO

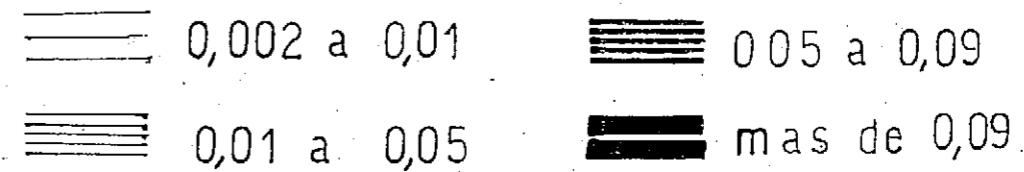

G 21

FECHA: ...
ESCALA: 1 : 1100.000

PROVINCIA DE
CORRIENTES

PROVINCIA DE
SANTA FE

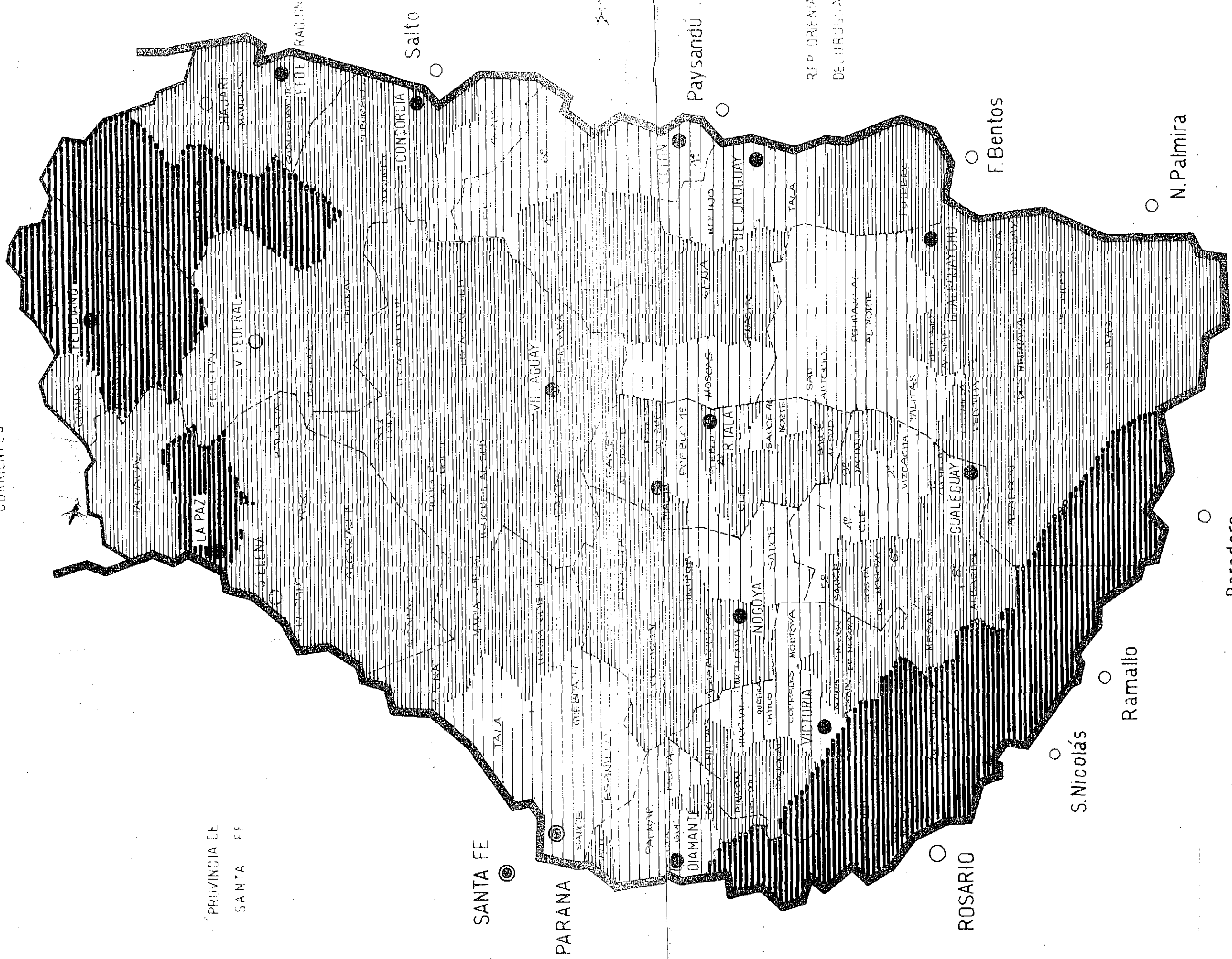

PROPORCION DE POBLACION MENORES DE 6 AÑOS POR DISTRITO

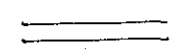
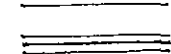
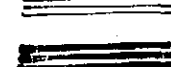
-  10% a 15%
-  15% a 20%
-  mas de 20%

G22

FE 1951
ECONOMIA

KM 0

PROVINCIA DE
CORRIENTES

PROVINCIA DE
SANTA FE

SANTA FE

PARANA

ROSARIO

S. Nicolás

Ramallo

Baradero

PROVINCIA DE
BUENOS AIRES

Salto



Paysandú

F. Bentos

N. Palmira

KM 0

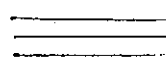
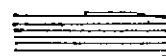
PROPORCION POBLACION DE 6 a 18 AÑOS POR DISTRITO

-  MENOS DE 28 %
-  28 % a 32 %
-  32 % y MAS

G23

FECHA:
ESCALA: 1 : 100.000

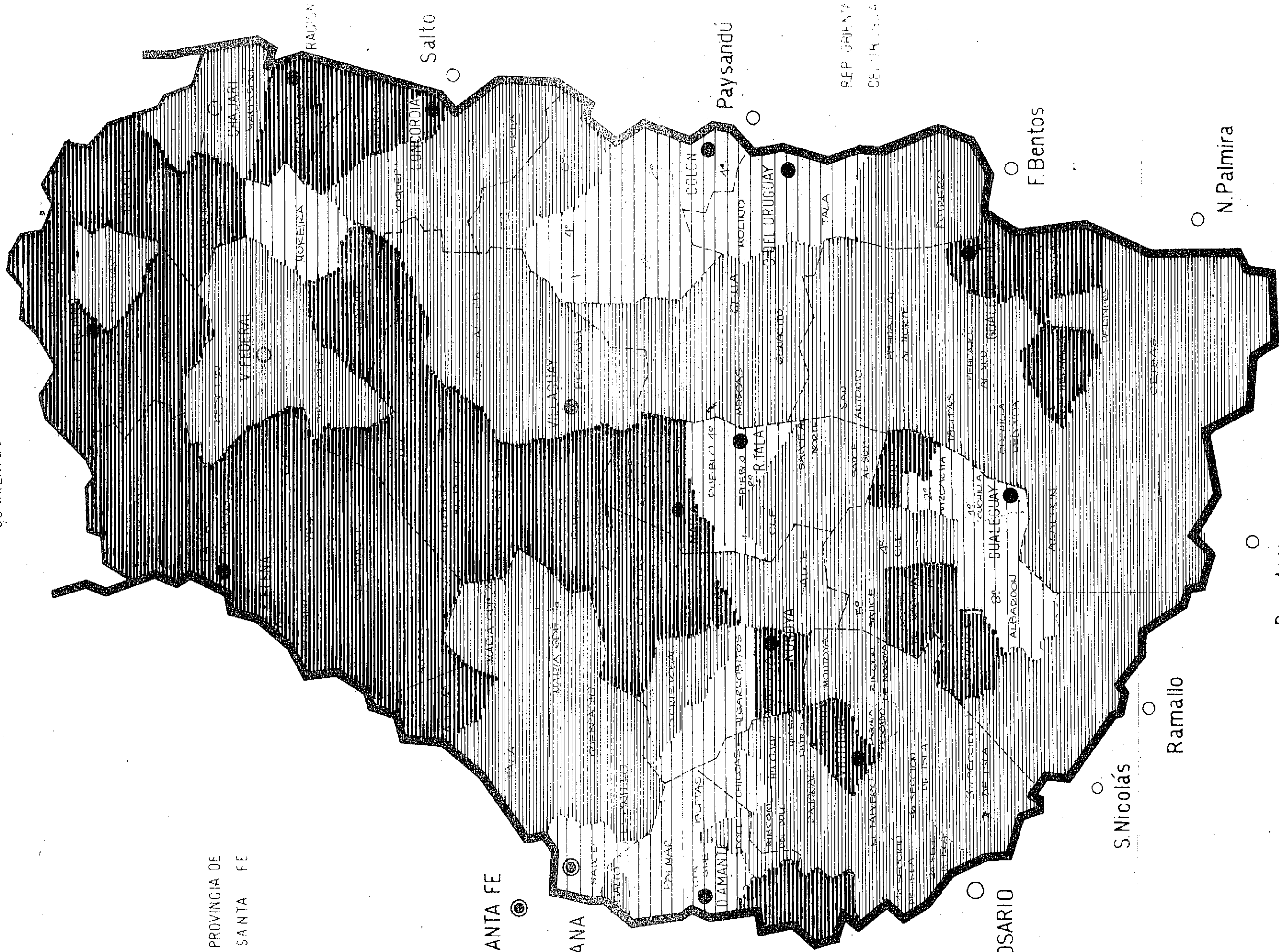

PROVINCIA DE
CORRIENTES



PROVINCIA DE
SANTA FE

SANTA FE

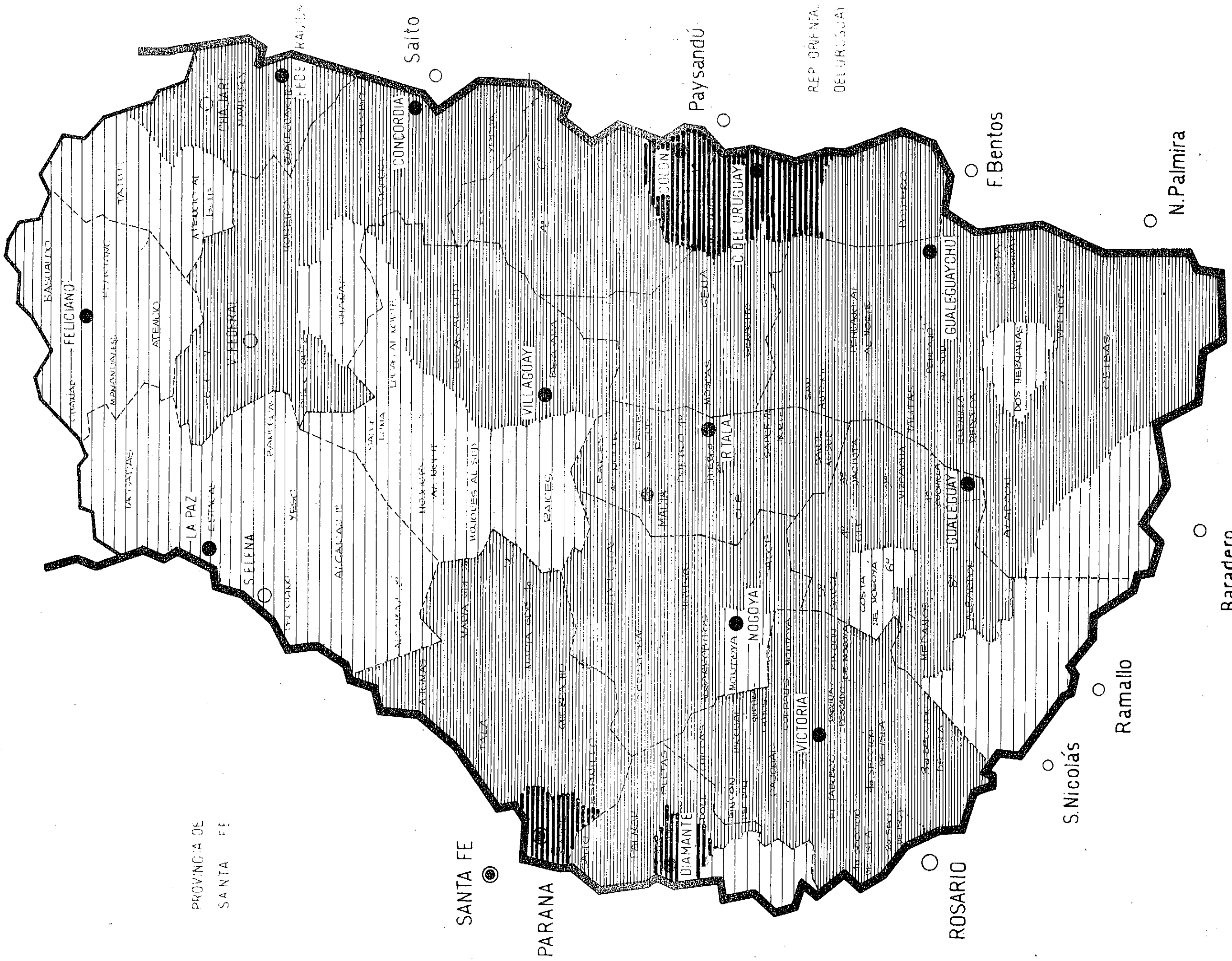
PARANA

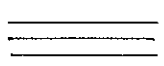

PROPORCION DE POBLACION MAYORES DE 18 ANOS POR DISTRITO

-  40% a 50%
-  50% a 60%
-  mas de 60%

G 24

FECHA:
ESCALA: 1:100.000



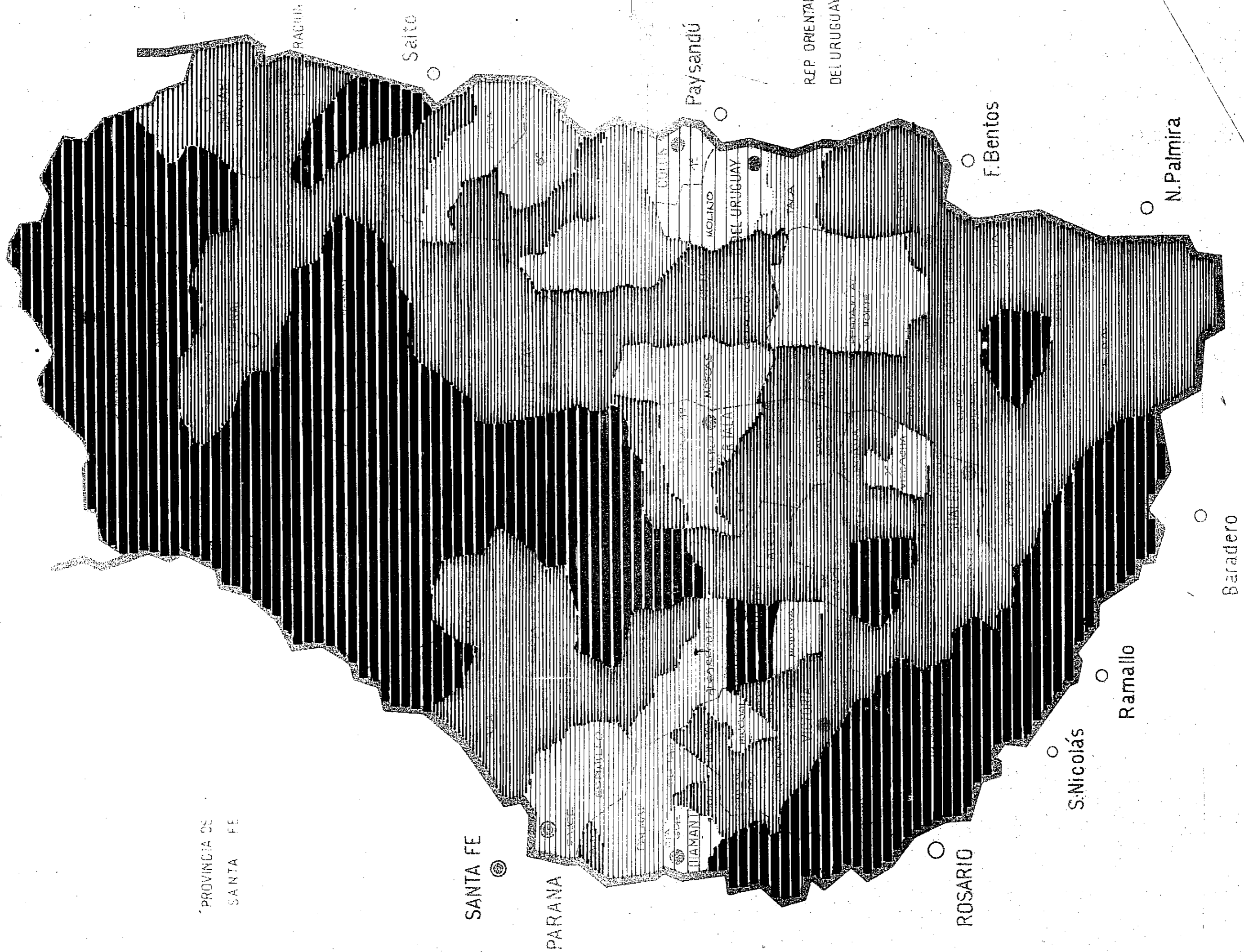

PROVINCIA DE
SANTA FE

SANTA FE

PARANA

TIJAMANI

ROSARIO

S. Nicolás

Ramallo

Baradero

PROVINCIA DE
BUENOS AIRES

PROPORCION POBLACION MENOR 18 AÑOS POR DISTRITO
EN RELACION CON PROMEDIO PROVINCIAL

34% a 40%

40% a 44%

44% a 50%

mas de 50%

G25

FECHA:
ESCALA: 1:100.000

KM 0 50

50

PROVINCIA DE
CORRIENTES

PROVINCIA DE
SANTA FE

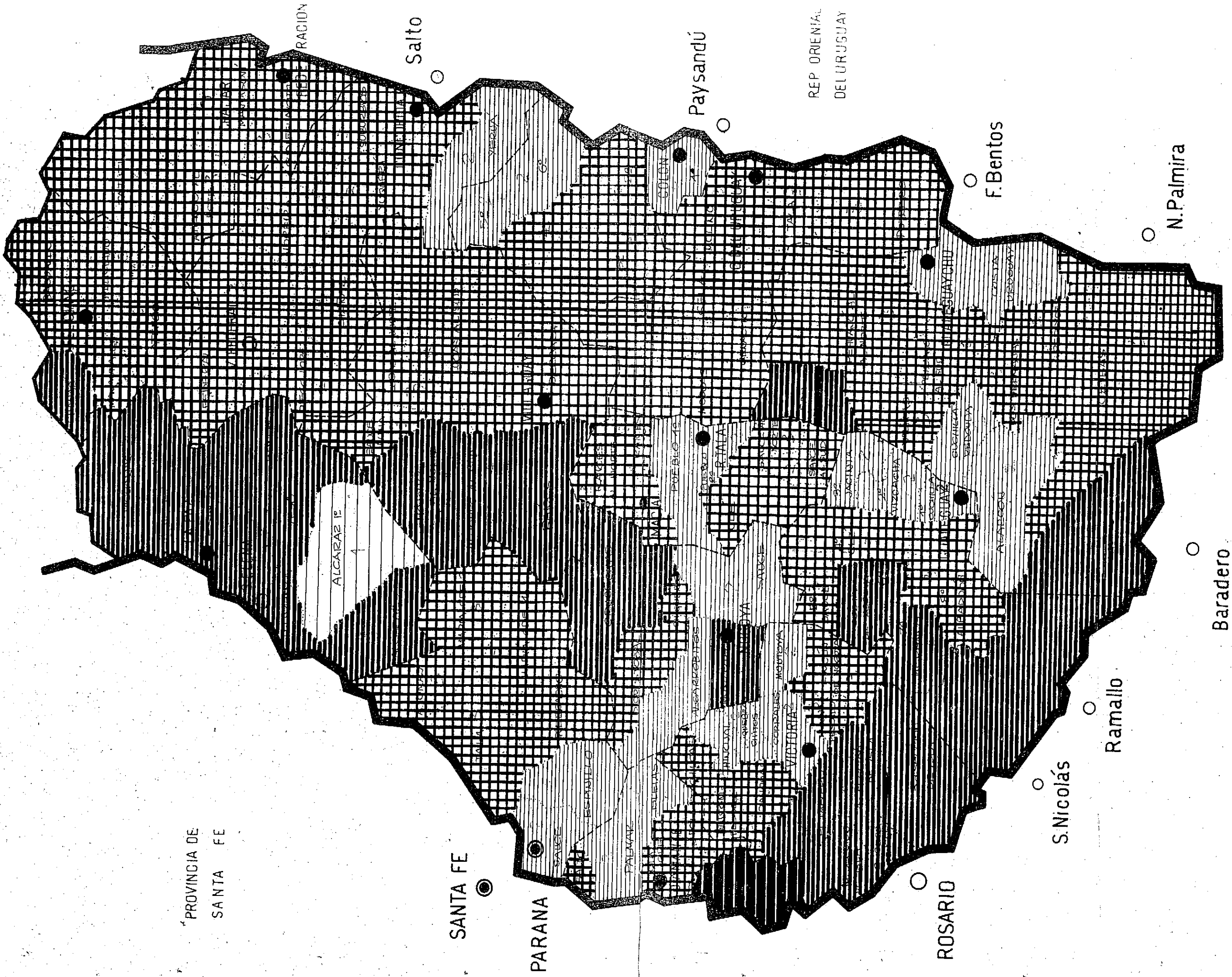

HACINAMIENTO Nº PERSONAS / Nº CUARTOS

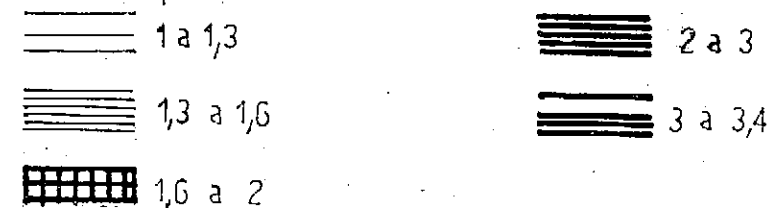

G 26

FECHA:
ESCALA: 1:100,000

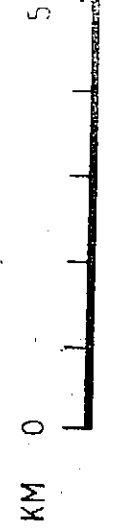

RECURSOS NATURALES

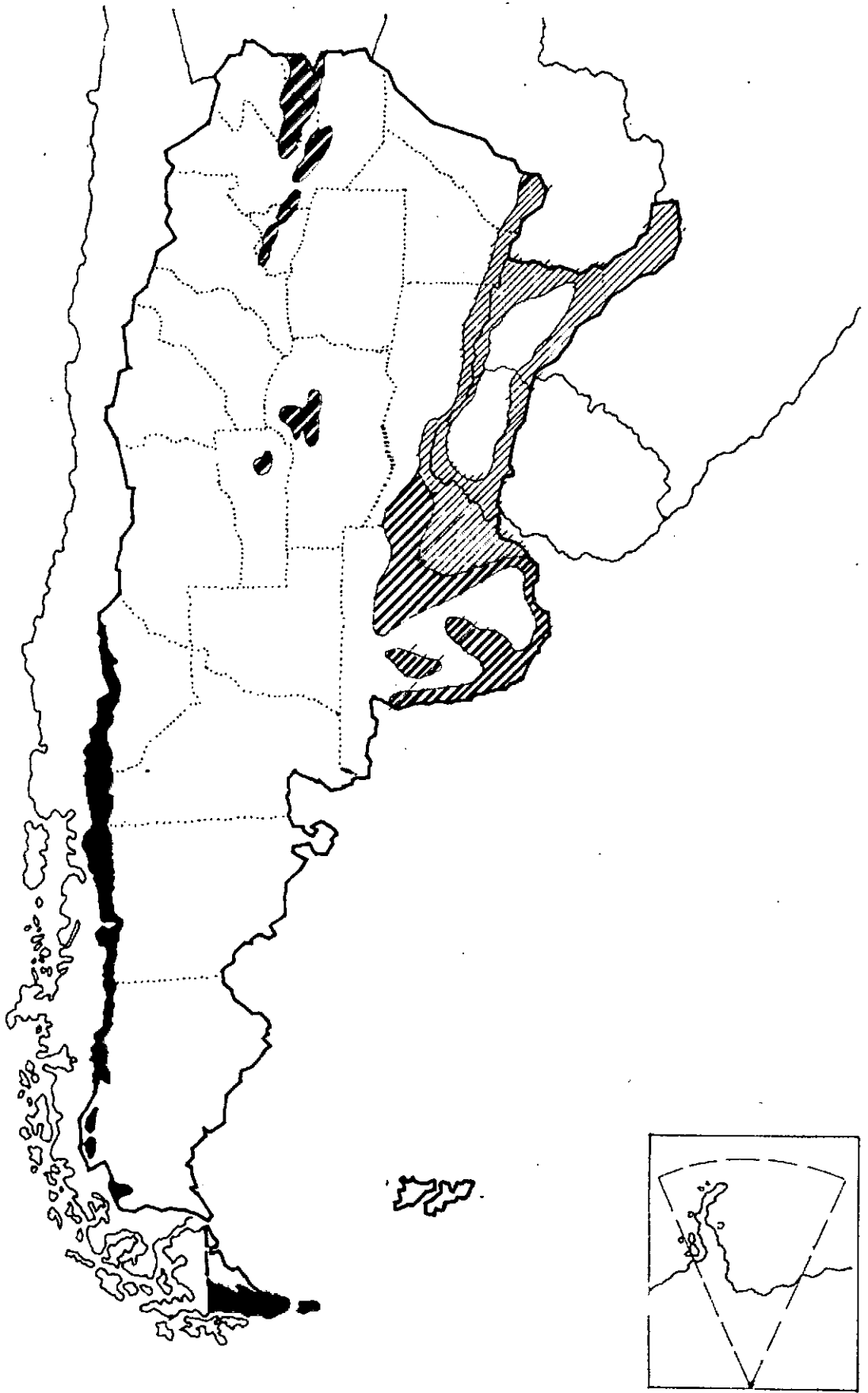

FUENTE : GOLFARI, "CULTIVO DE CONIFERAS"

ARGENTINA MAYOR APTITUD P/ CULTIVO PINOS Y OTRAS CONIFERAS





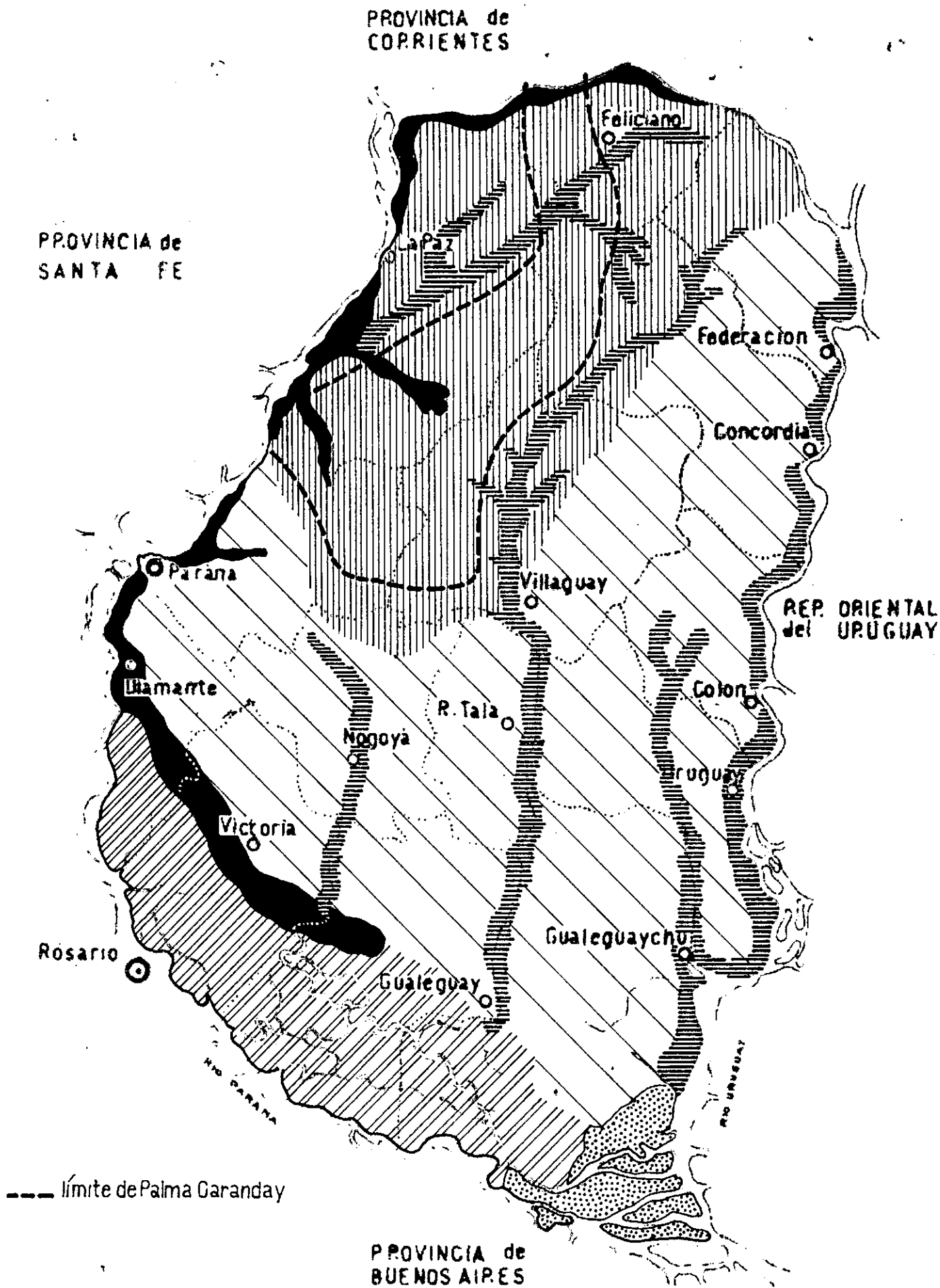

- | | | | |
|------------------------------------------------------------------------------------|----------|-------------------------------------------------------------------------------------|----------|
|  | REGION 2 |  | REGION 3 |
|  | REGION 1 |  | REGION 4 |

IPRUL 1964

0 100 KM. 500



E.RIOS FORMACIONES FORESTALES

- | | |
|---------------------------------------------------------------------------------------------------------------|---------------------------------------------------------------------------------------------------------------------------------|
|  FORMACION DEL MONTIEL |  MONTE COSTANERO DE LAS BARRANCAS del PARANA |
|  FORMACION DE LA PRADERA |  BOSQUE FLUVIAL |
|  FORMACION DELTICO LACUSTRE |  MONTE COSTANERO del URUGUAY |

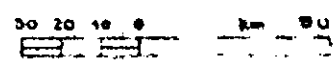

PROVINCIA de
CORRIENTES

PROVINCIA de
SANTA FE



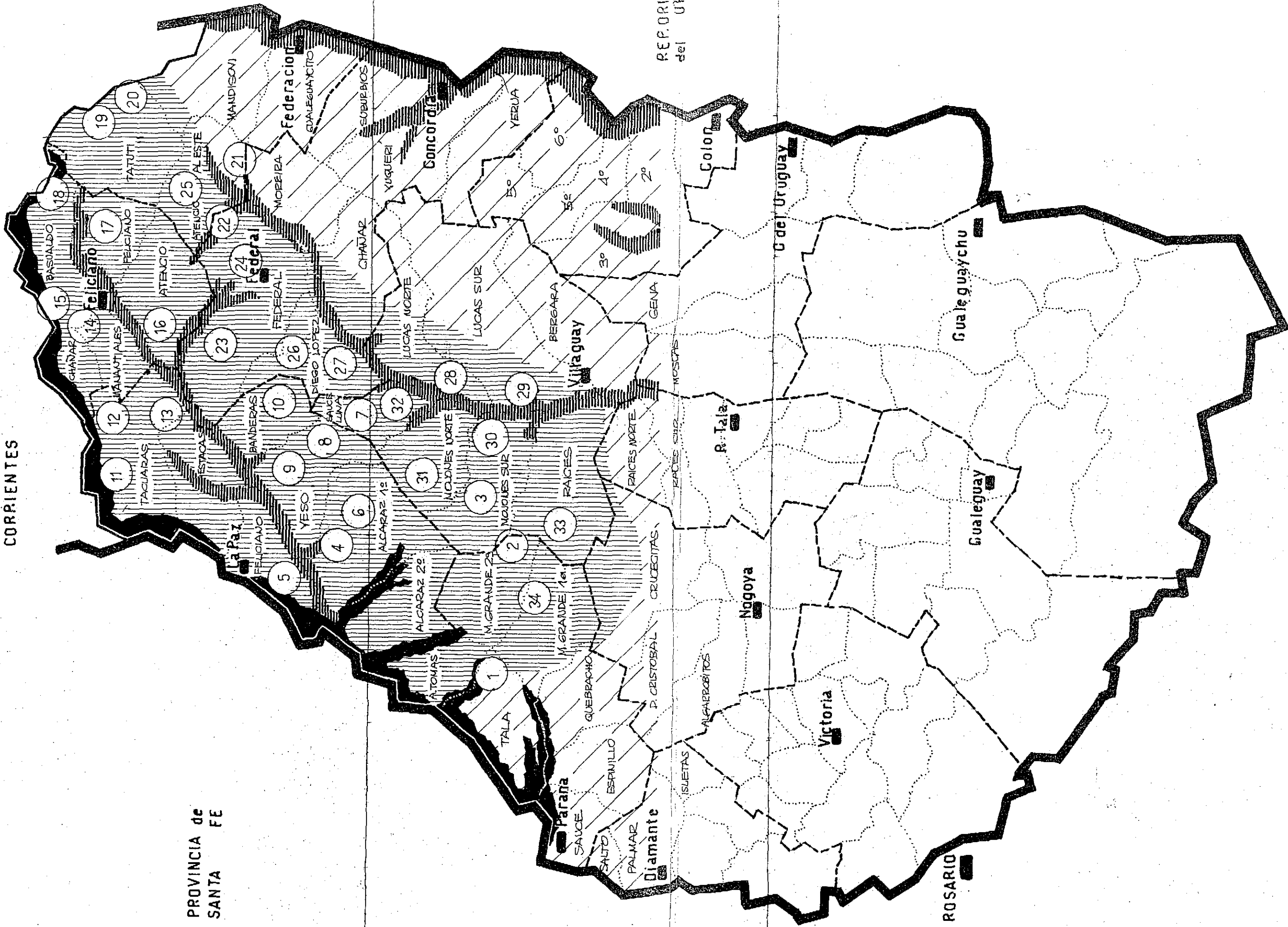

REP. ORIENTAL
del URUGUAY

--- limite departamentos
- - - limite distritos

PROVINCIA de
BUENOS AIRES



FORMACION FORESTAL DEL MONTIEL

-  FORMACION DE LA PRADERA
-  " DEL MONTE XERÓFILO
-  MONTE COSTANERO del URUGUAY
-  MONTE COSTANERO DE LAS BARRANCAS DEL PARANA
-  ZONA BATIQA POR EL RECONOCIMIENTO

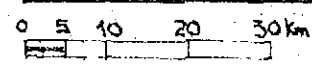

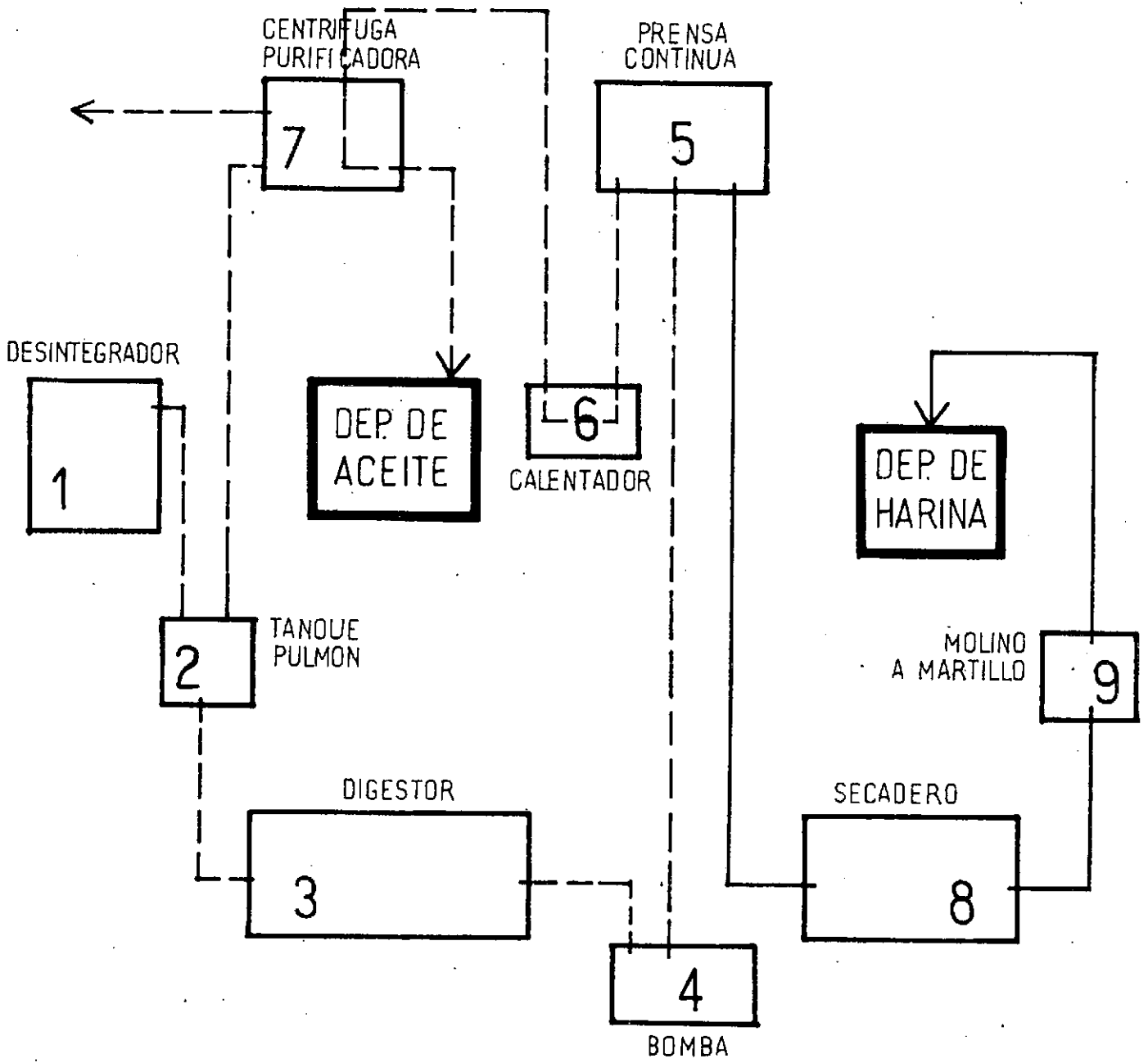

ELABORACION DE ACEITE Y HARINA DE PESCADO - FLOWSHEET

AGRICULTURA

PROVINCIA de
CORRIENTES

PROVINCIA de
SANTA FE

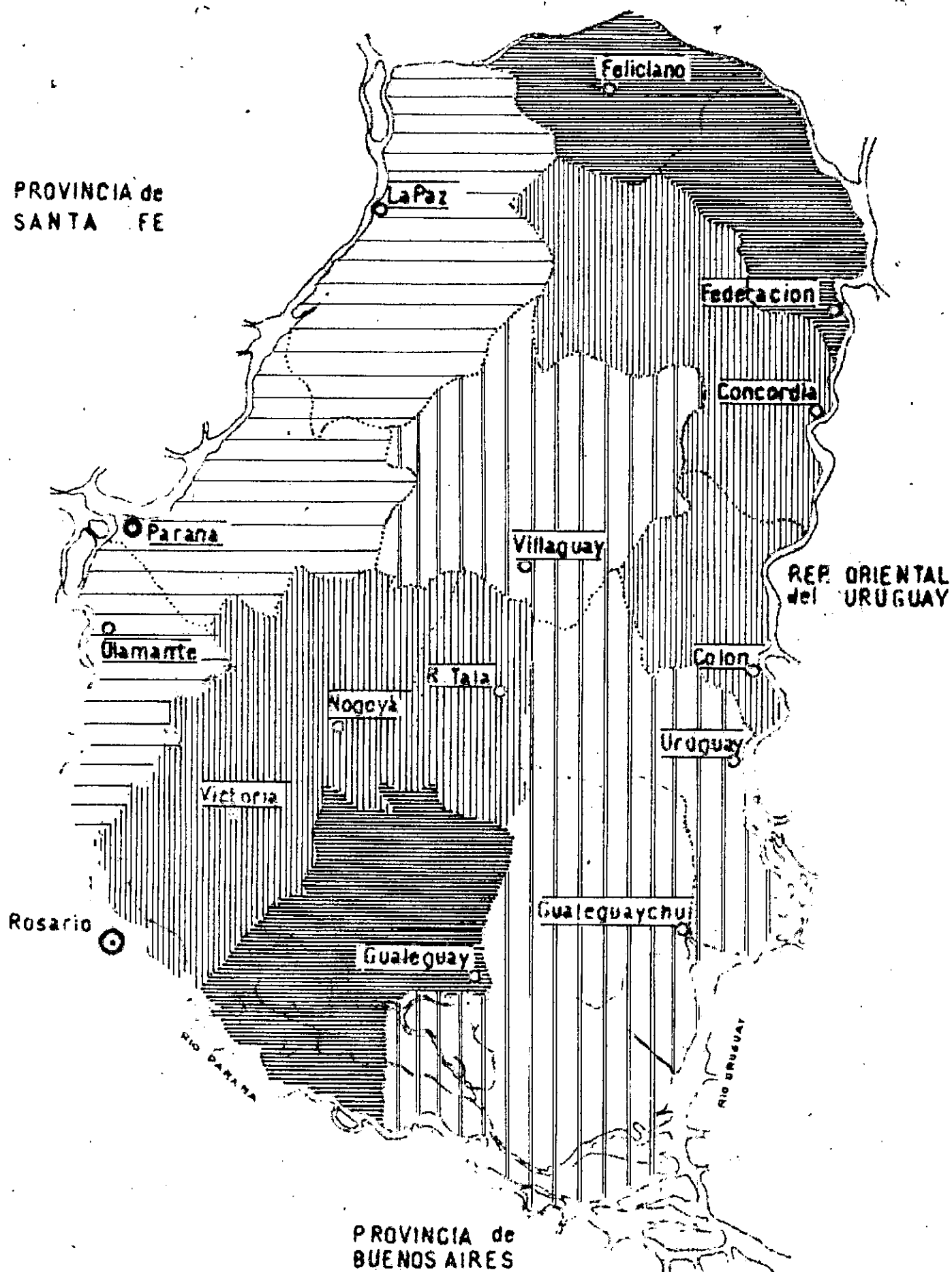

PROVINCIA de
BUENOS AIRES

ENTRE RIOS PORCENTAJE DE SUPERFICIE DEDICADA AL PASTOREO

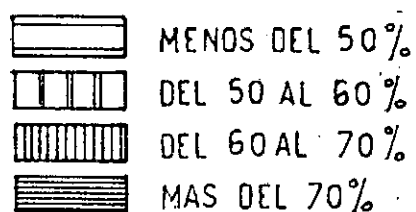

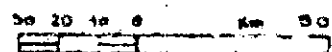

MAPA N° 1

dic. 1963

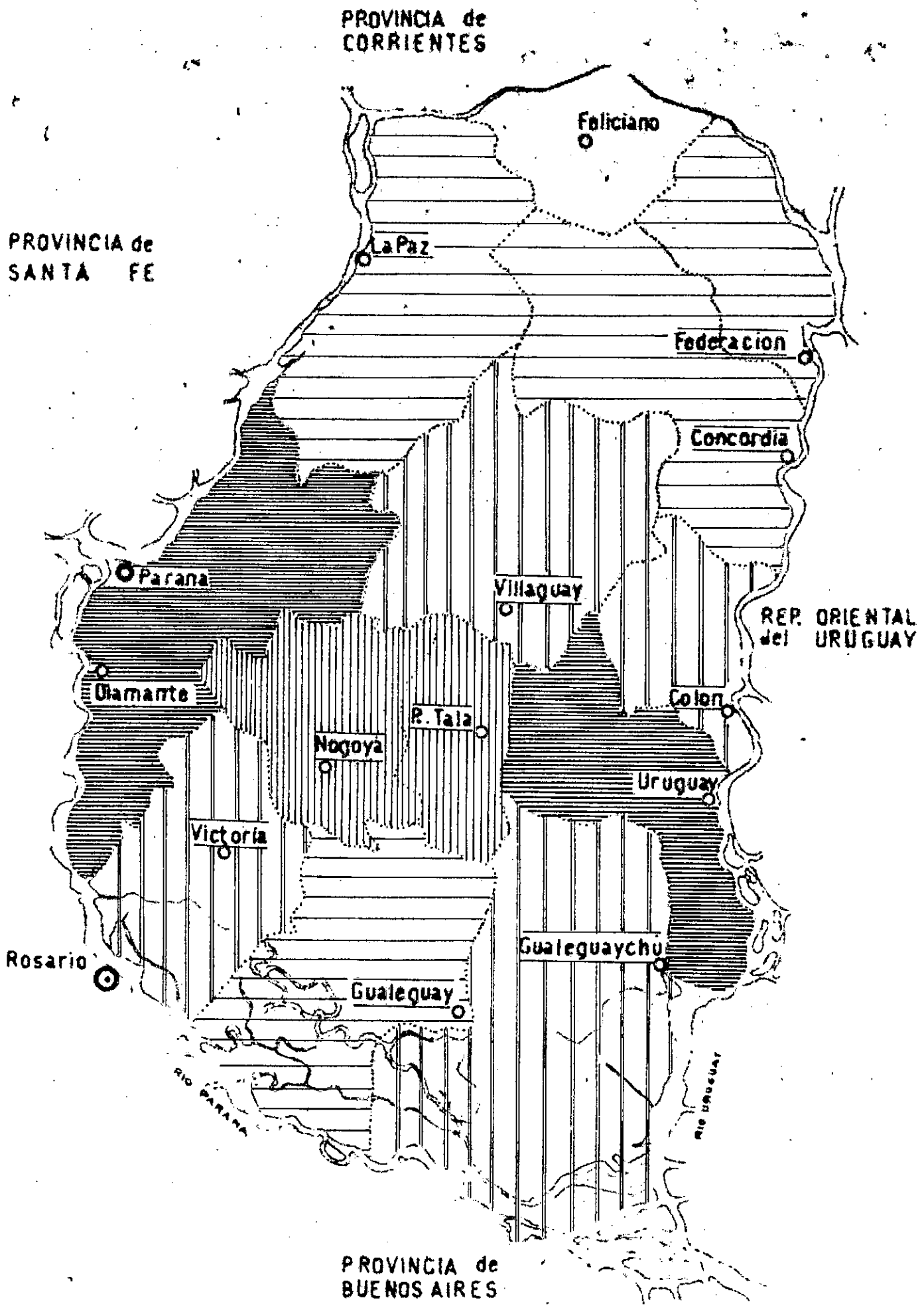

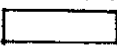
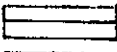
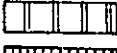

ENTRE RIOS PORCENTAJE SUPERFICIE DEDICADA A LA AGRICULTURA.

	MENOS DEL 5%	MAPA Nº 2
	DEL 5 AL 10 %	
	DEL 10 AL 15 %	
	DEL 15 AL 20 %	
	DEL 25 AL 30 %	

dic. 1963

50 20 10 0 Km 100

PROVINCIA de
CORRIENTES

PROVINCIA de
SANTA FE

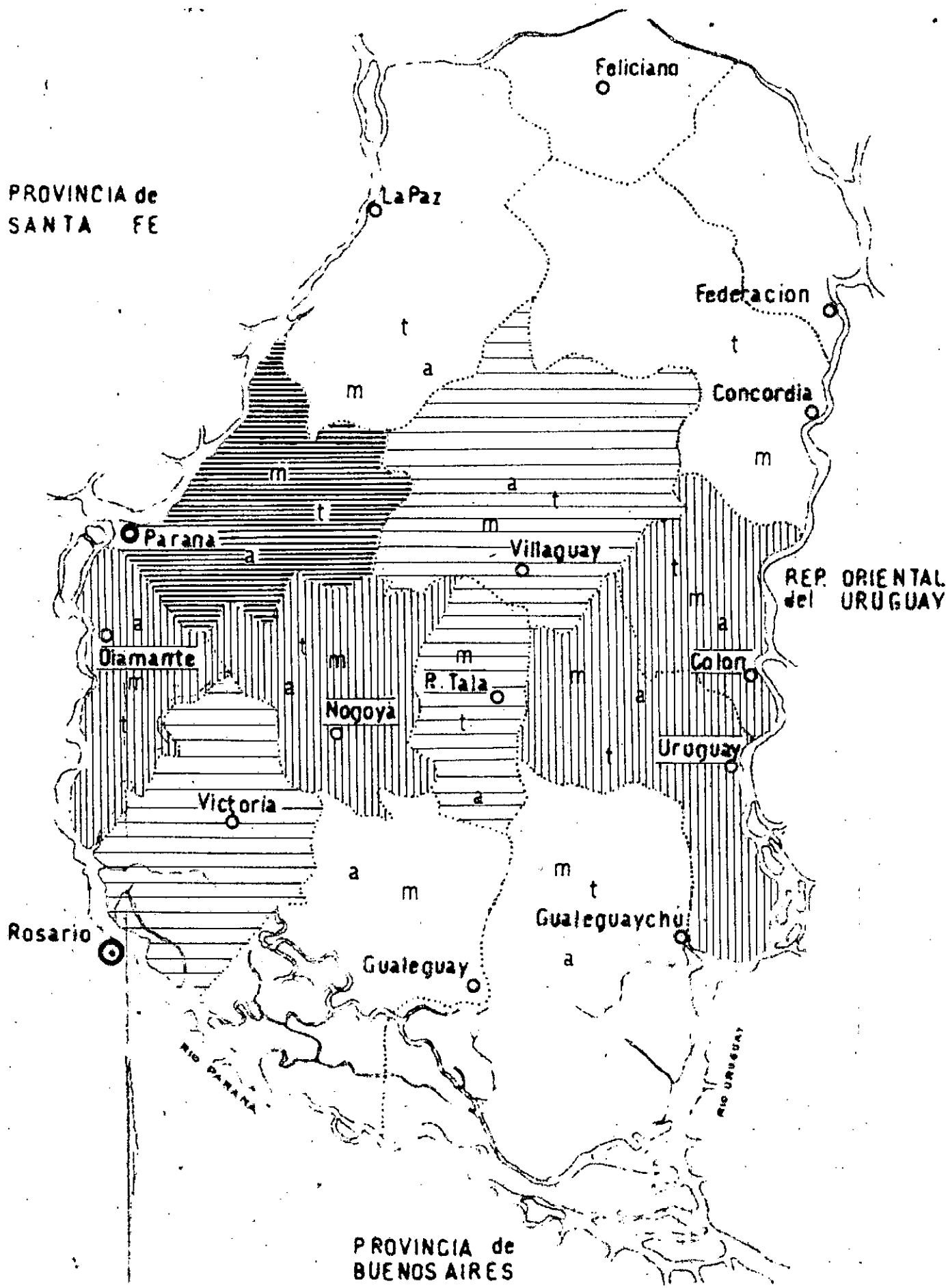

ENTRE RIOS / PORCENTAJE SUPERFICIE SEMBRADA SOBRE SUPERFICIE TOTAL.

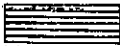
-  MENOS DEL 2 %
-  DEL 2 AL 5 %
-  DEL 5 AL 10 %
-  MAS DEL 10 %

MAPA N° 3

dic. 1963



PROVINCIA de
CORRIENTES

PROVINCIA de
SANTA FE

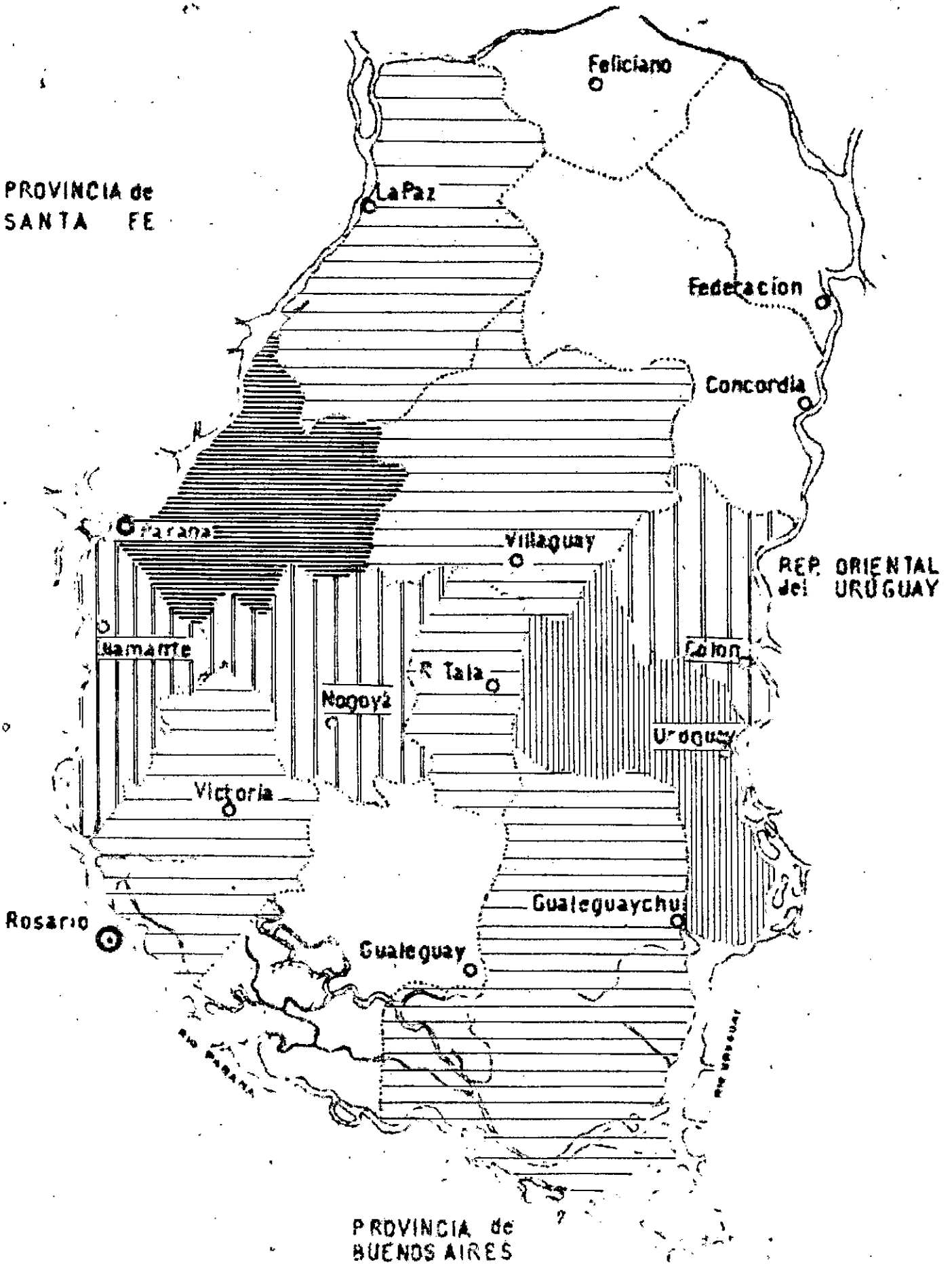

ENTRE RIOS MAÍZ PRODUCCION ANUAL

- DE 10.000 A 15.000 tt.
- DE 15.000 A 20.000 tt.
- DE 20.000 A 30.000 tt.
- MAS DE 30.000 tt.

MAPA N° 4

dic. 1963

0 50 100 200

PROVINCIA de
CORRIENTES

PROVINCIA de
SANTA FE

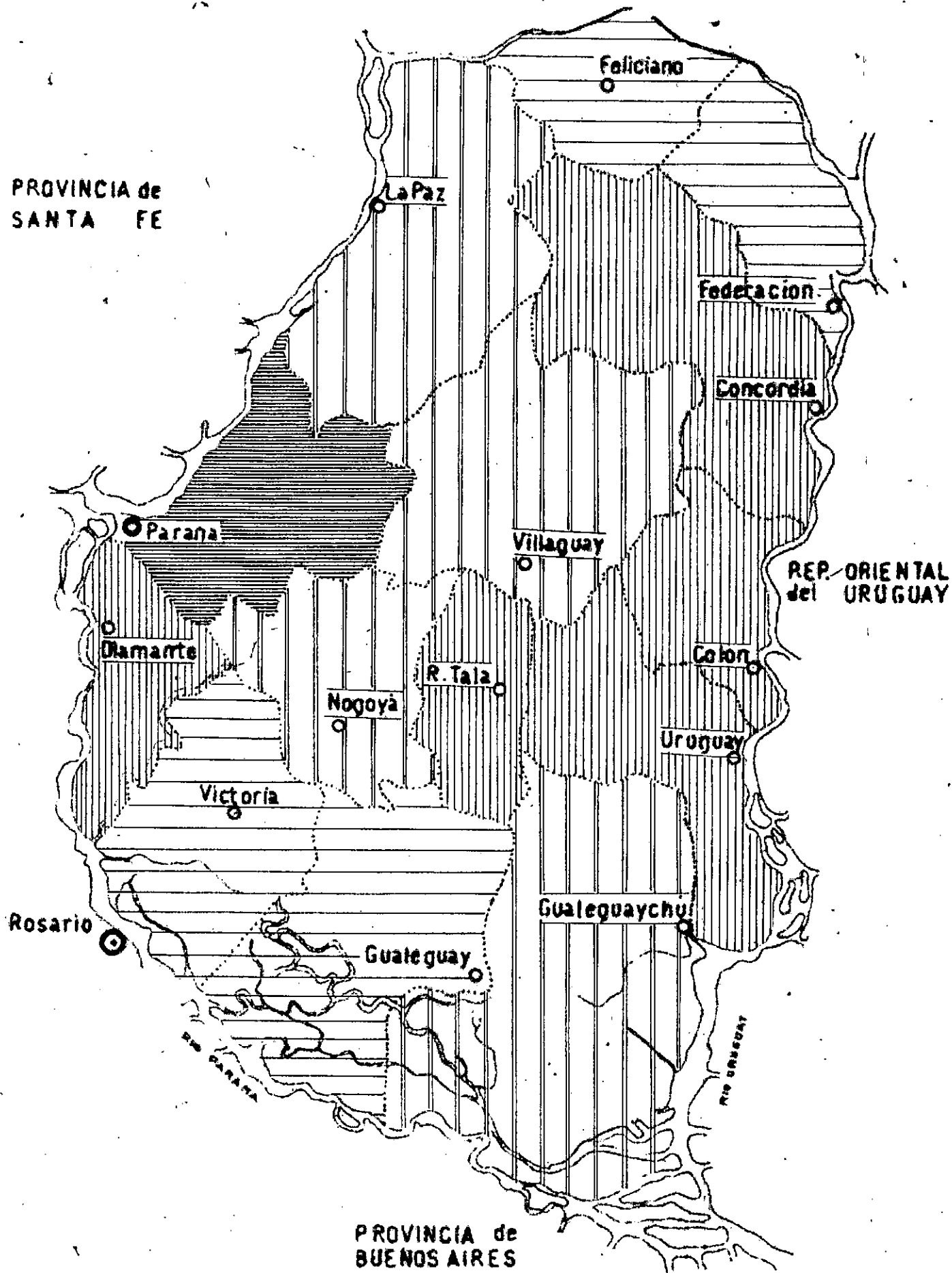

ENTRE RIOS TRIGO PORCENTAJE SUPERFICIE SEMBRADA SOBRE SUPERFICIE TOTAL.

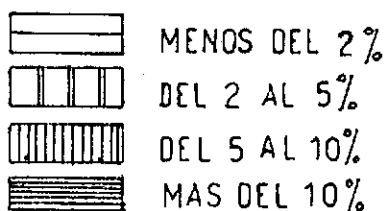

MAPA N° 5

dic. 1963

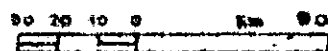

PROVINCIA de
CORRIENTES

PROVINCIA de
SANTA FE

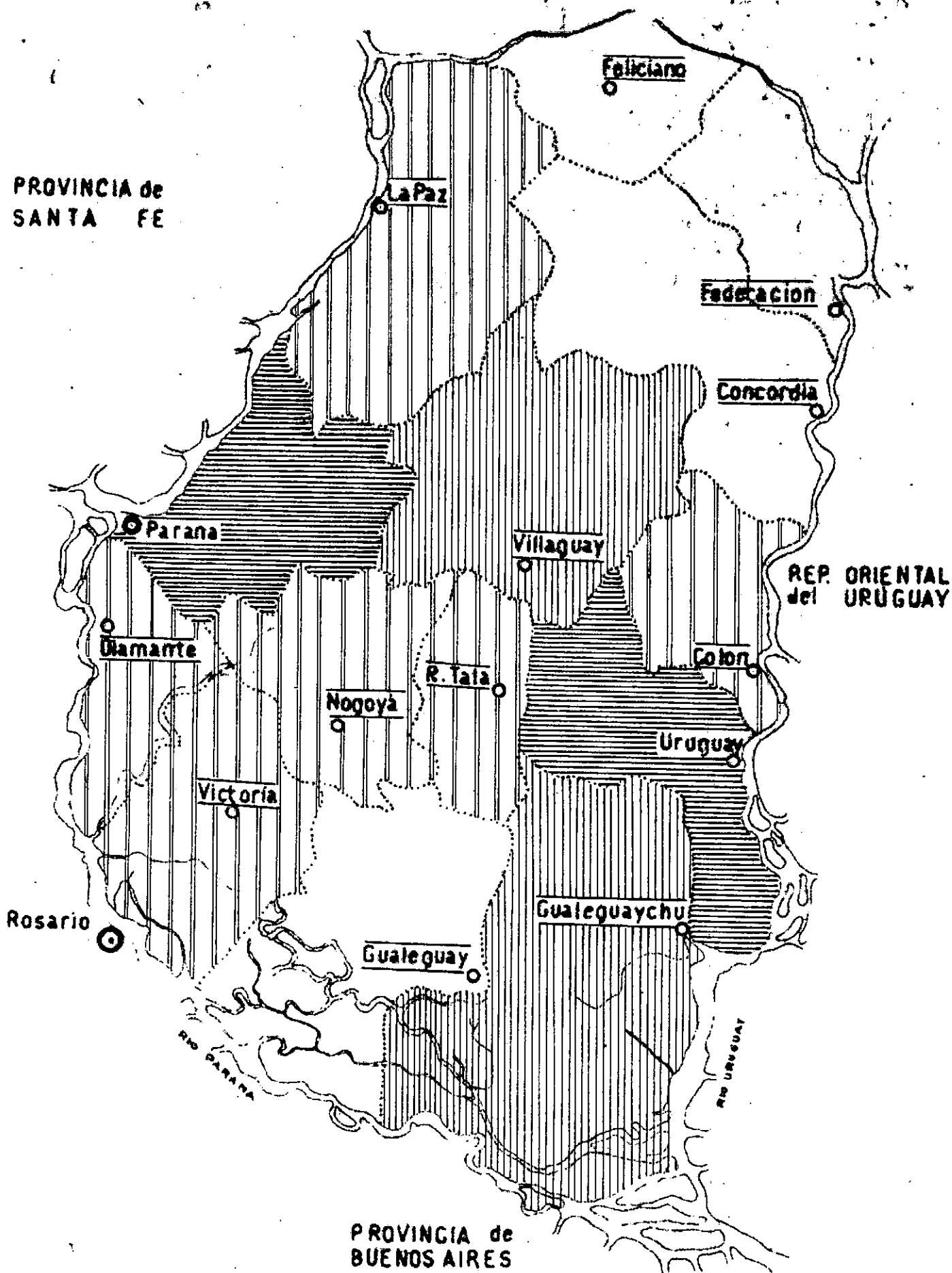

ENTRE RIOS TRIGO-PRODUCCION ANUAL

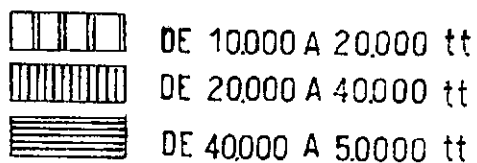

MAPA N°6

dic.1963

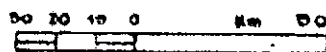

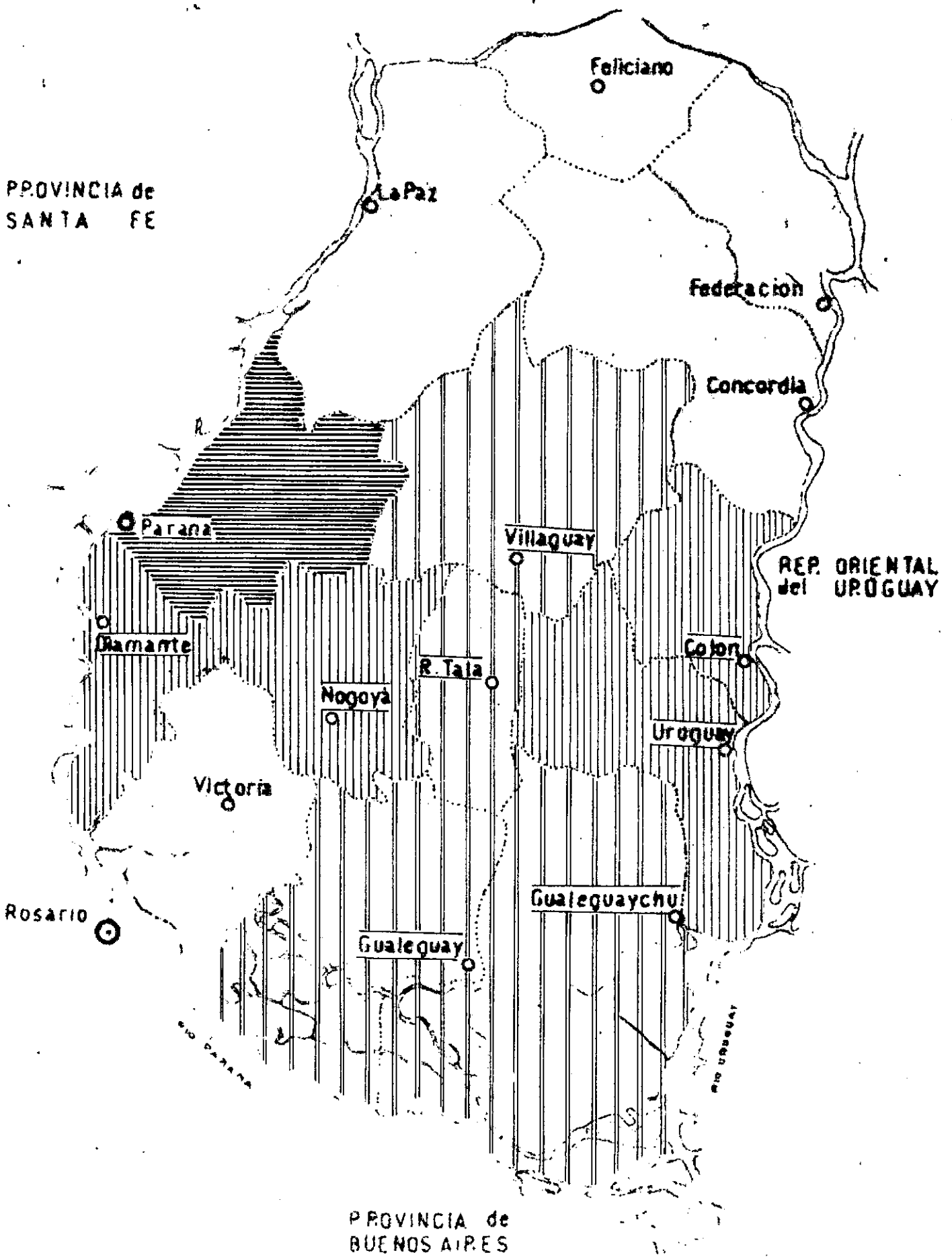

PROVINCIA de
CORRIENTES

PROVINCIA de
SANTA FE



PROVINCIA de
BUENOS AIRES

ENTRE RIOS EXISTENCIA DE AVES 1960

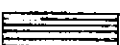
-  MENOS DE 250.000
-  DE 250.000 A 500.000
-  DE 500.000 A 1.000.000
-  MAS DE 1.000.000

MAPA N° 7

dic. 1963



PROVINCIA de
CORRIENTES

PROVINCIA de
SANTA FE

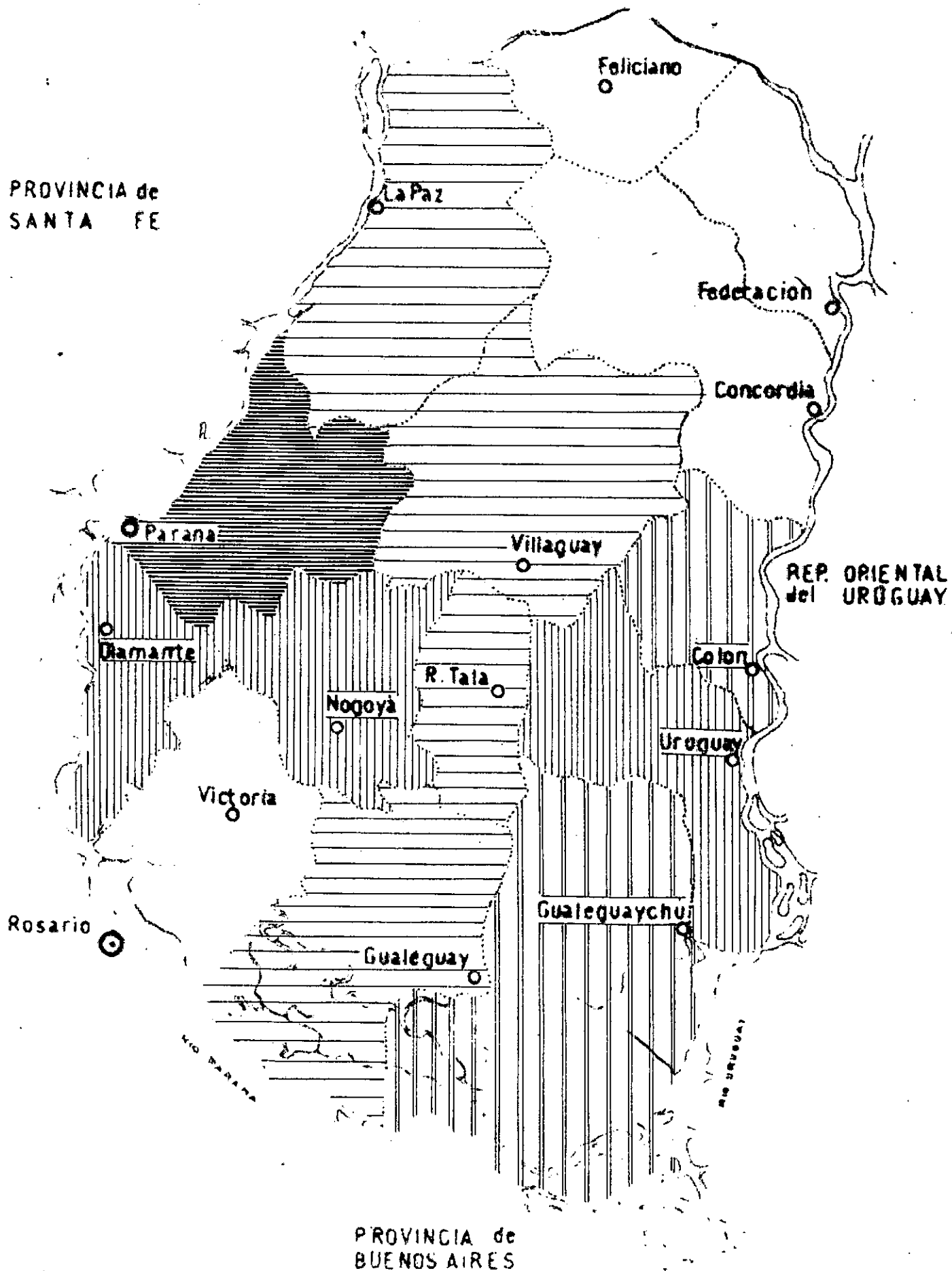

PROVINCIA de
BUENOS AIRES

ENTRE RIOS PRODUCCION DE HUEVOS ANUAL.

	DE 1.000.000 A 2.500.000 DE DOCENAS
	DE 2.500.000 A 5.000.000 " "
	DE 5.000.000 A 10.000.000 " "
	MAS DE 10.000.000 " "

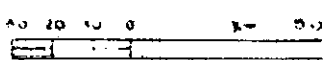

MAPA N°8

dic. 1963

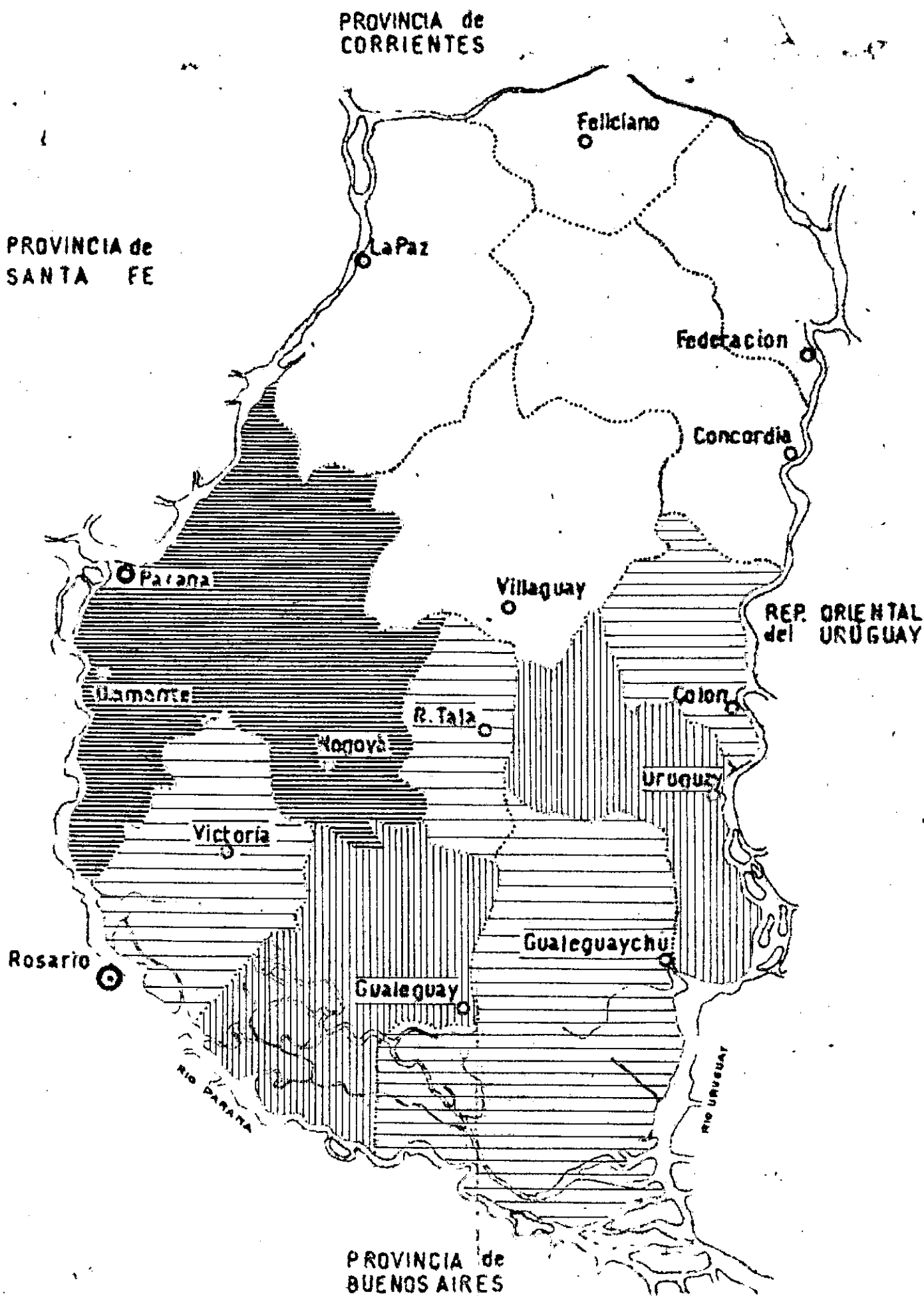

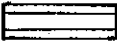

ENTRE RIOS PROMEDIO EXISTENCIA DE AVES POR UNIDAD DE EXPLOTACION - 1960

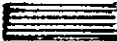
-  MENOS DE 200
-  DE 200 A 300
-  DE 300 A 400
-  MAS DE 400

MAPA N° 9

dic. 1963

0 10 20 30 40 50 60 70 80 90 100

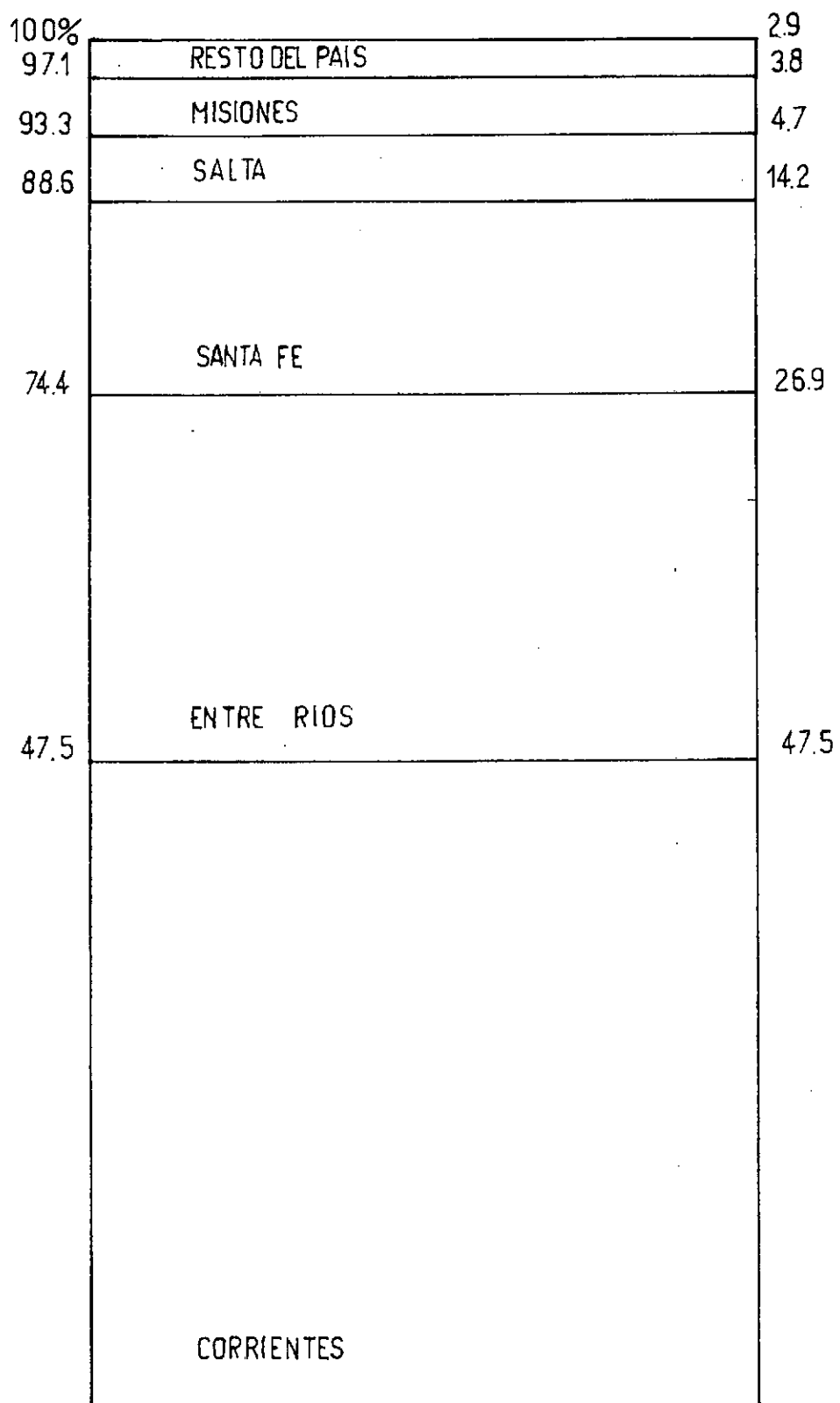

ARROZ SUPERF. PROMEDIO PORCENTUAL DEL TOTAL DEL PAIS

SEBRADO EN EL PERIODO 1952 /53 1962 /63



IPRUL 1964

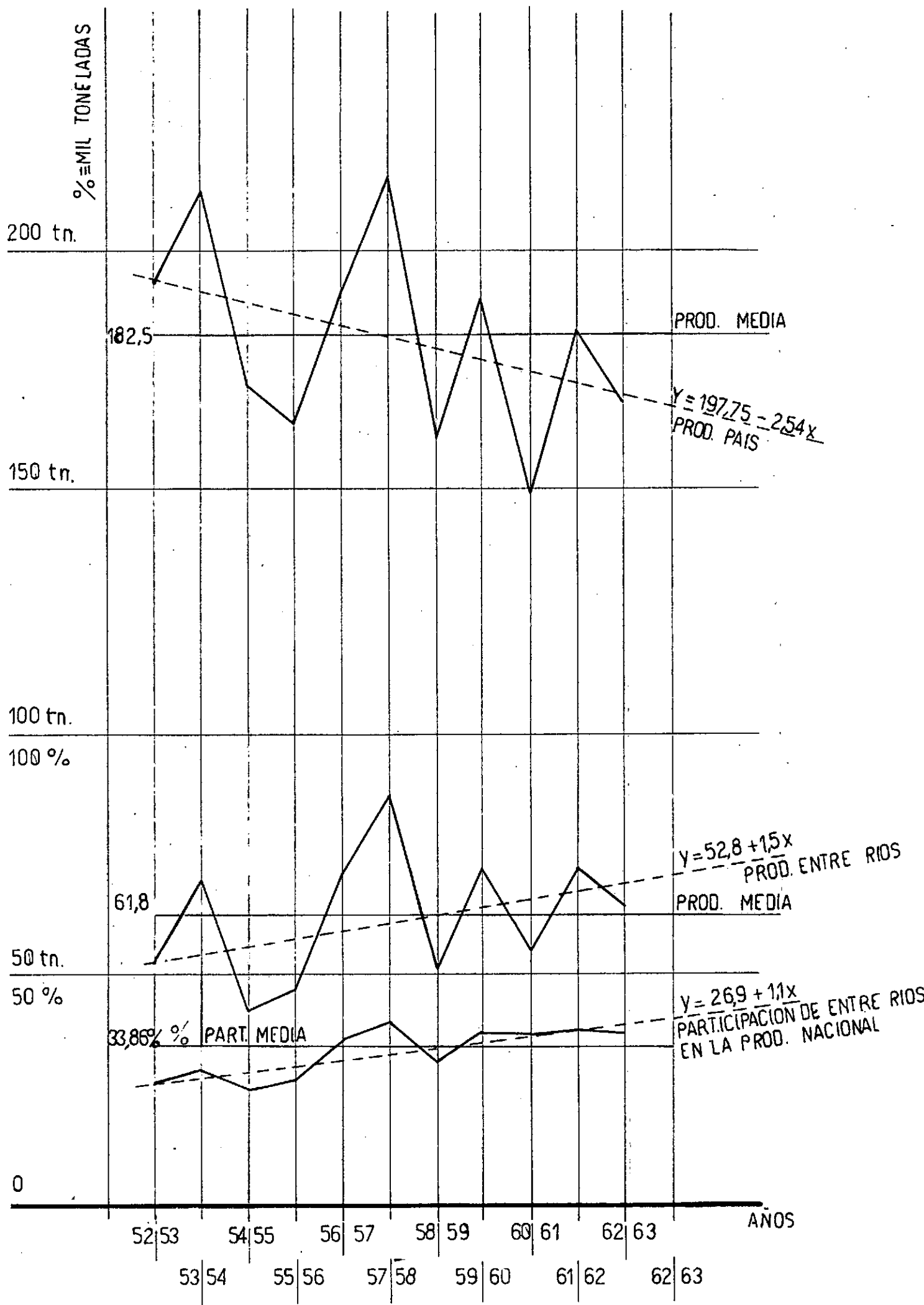

PRODUCCION DE ARROZ

G

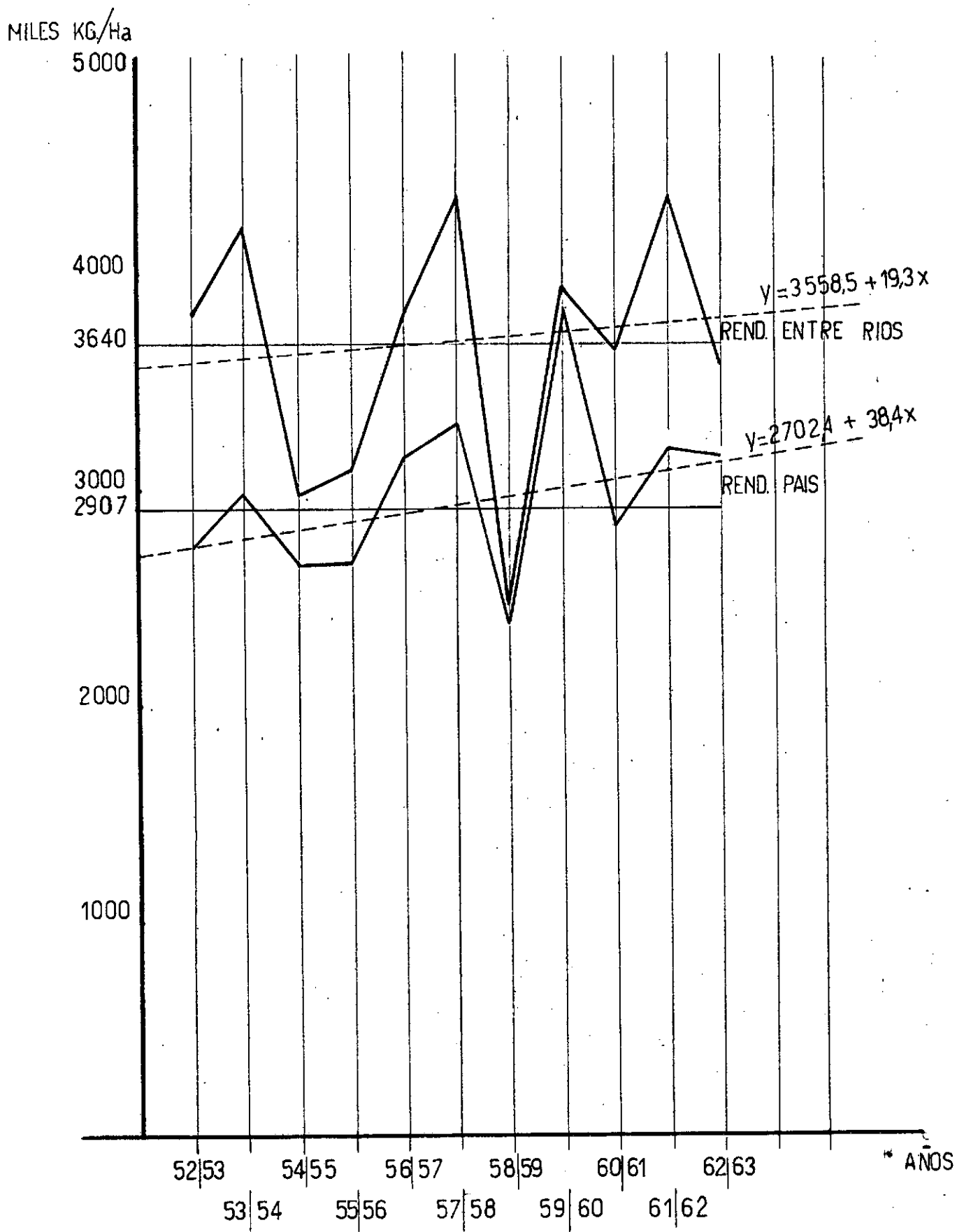

ARROZ

RENDIMIENTO EN Kg/Ha PROMEDIOS ANUALES Y DEL PERIODO

GRAFICOS COMPARATIVOS DE ENTRE RIOS Y EL PAIS

----- TENDENCIA



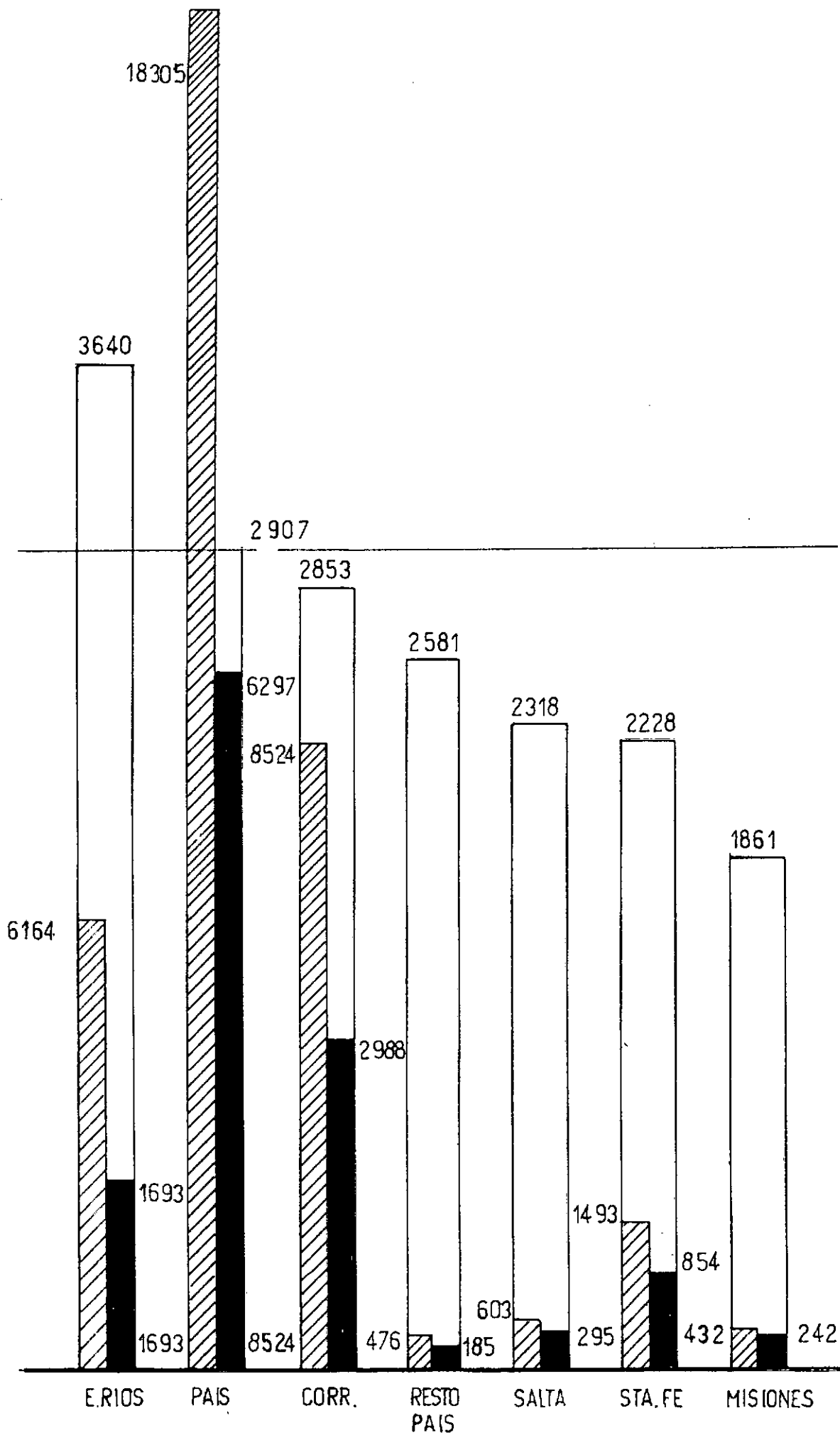

ARROZ

PERIODO 1952/53 A 1962/63

- RENDIMIENTO PROMEDIO EN KGR/ha
- PRODUCCION PROMEDIO MILES/tn
- SUPERFICIE SEMBRADA PROMEDIO EN MILES/Ha.



IPRUL

1964

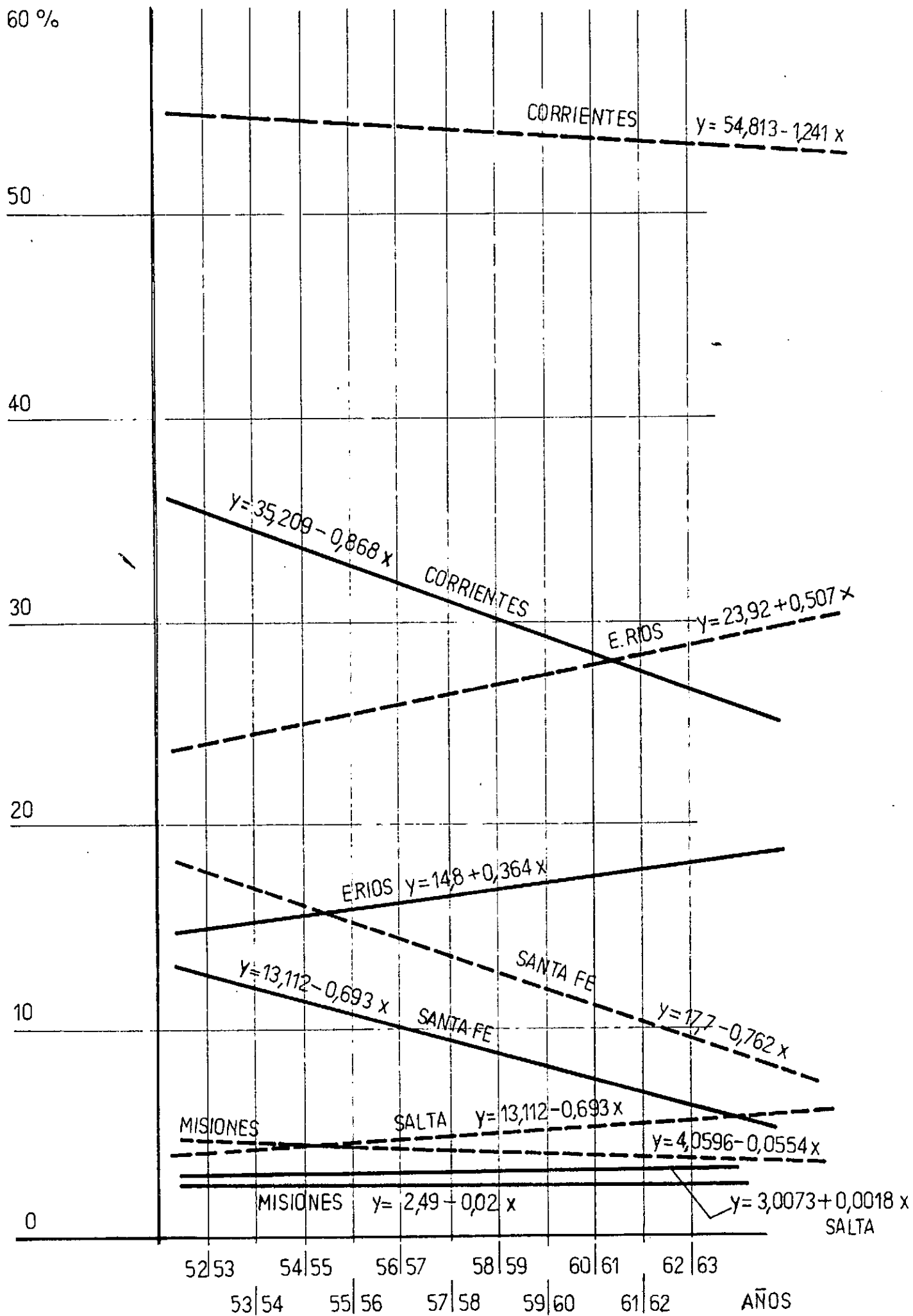

SUPERFICIES DE SIEMBRA PROVINCIALES - TENDENCIAS Y PARTICIPACION

_____ SUPERFICIES PROVINCIALES
 - - - - - PARTICIPACIONES % SOBRE TOTAL NACIONAL



ANALISIS ECONOMICO

E S T R U C T U R A E C O N Ó M I C A

1953

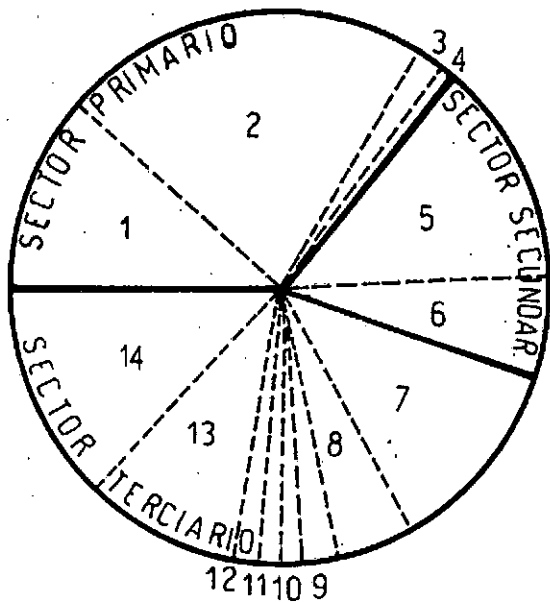

1958

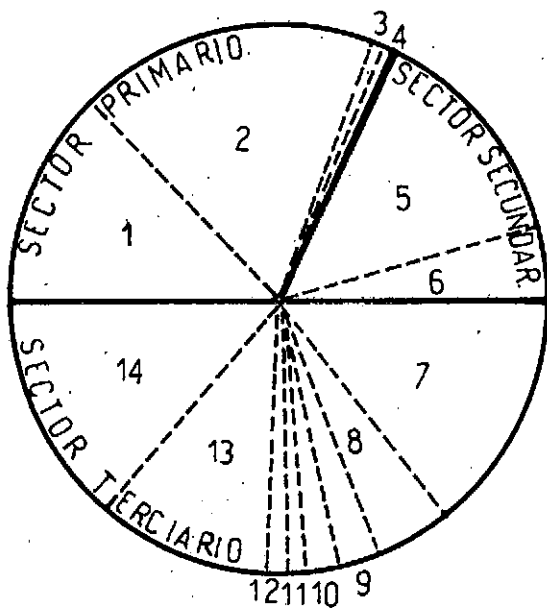

1959

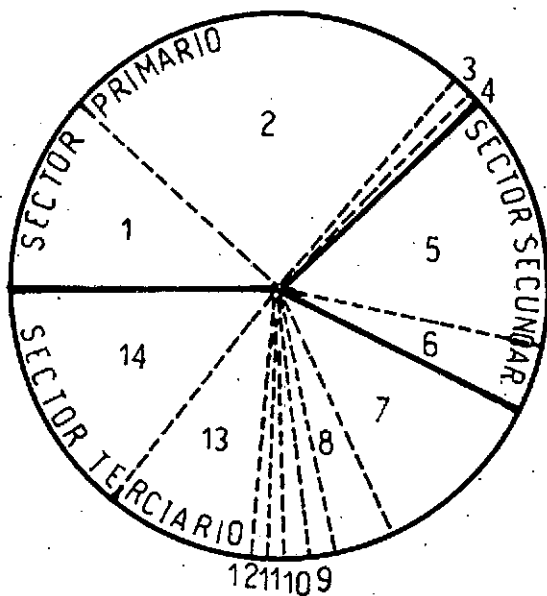

- 1- AGRICULTURA.
- 2- GANADERIA.
- 3- MINERIA.
- 4- PESCA.

- 5- IND. MANUFACTURERA
- 6- CONSTRUCCION.



- 7- GOBIERNO.
- 8- OTROS SERVICIOS.
- 9- VIVIENDA.
- 10- FINANZAS.
- 11- ELECT. Y O. SANIT.
- 12- COMUNICACIONES.
- 13- TRANSPORTE.
- 14- COMERCIO.

ENTRE RIOS VALOR AGREGADO BRUTO.

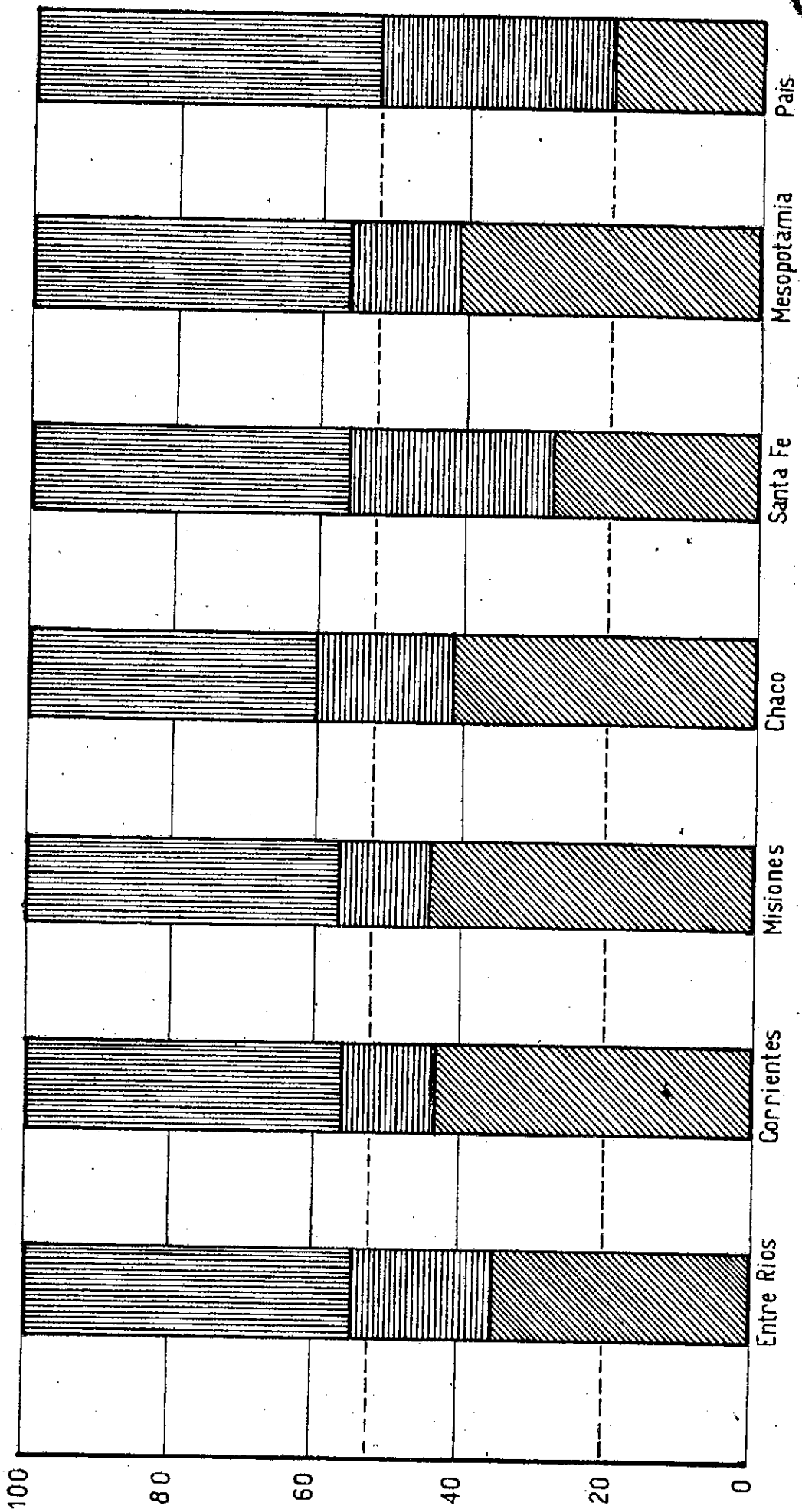
AÑO 1953



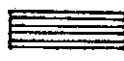

COMPOSICION DEL VALOR AGREGADO BRUTO A C.F. PARA VARIAS PROVINCIAS Y EL PAIS POR GRANDES SECTORES DE ACTIVIDAD.

-  SECTOR PRIMARIO.
-  SECTOR SECUNDARIO.
-  SECTOR TERCIARIO.

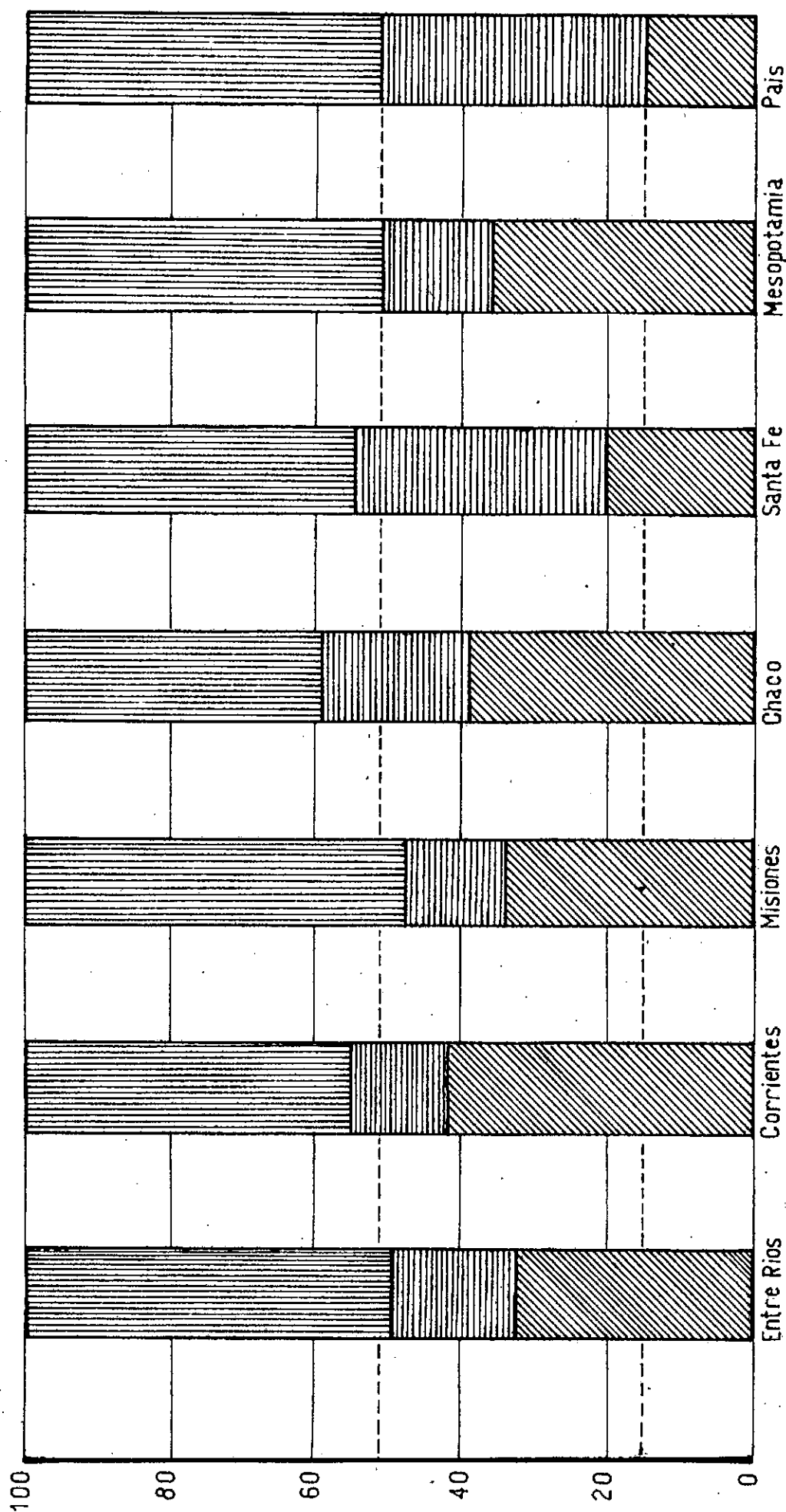
AÑO 1958

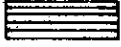

COMPOSICION DEL VALOR AGREGADO BRUTO A C.F. PARA VARIAS PROVINCIAS Y EL PAIS POR GRANDES SECTORES DE ACTIVIDAD.



-  SECTOR PRIMARIO
-  SECTOR SECUNDARIO
-  SECTOR TERCIARIO

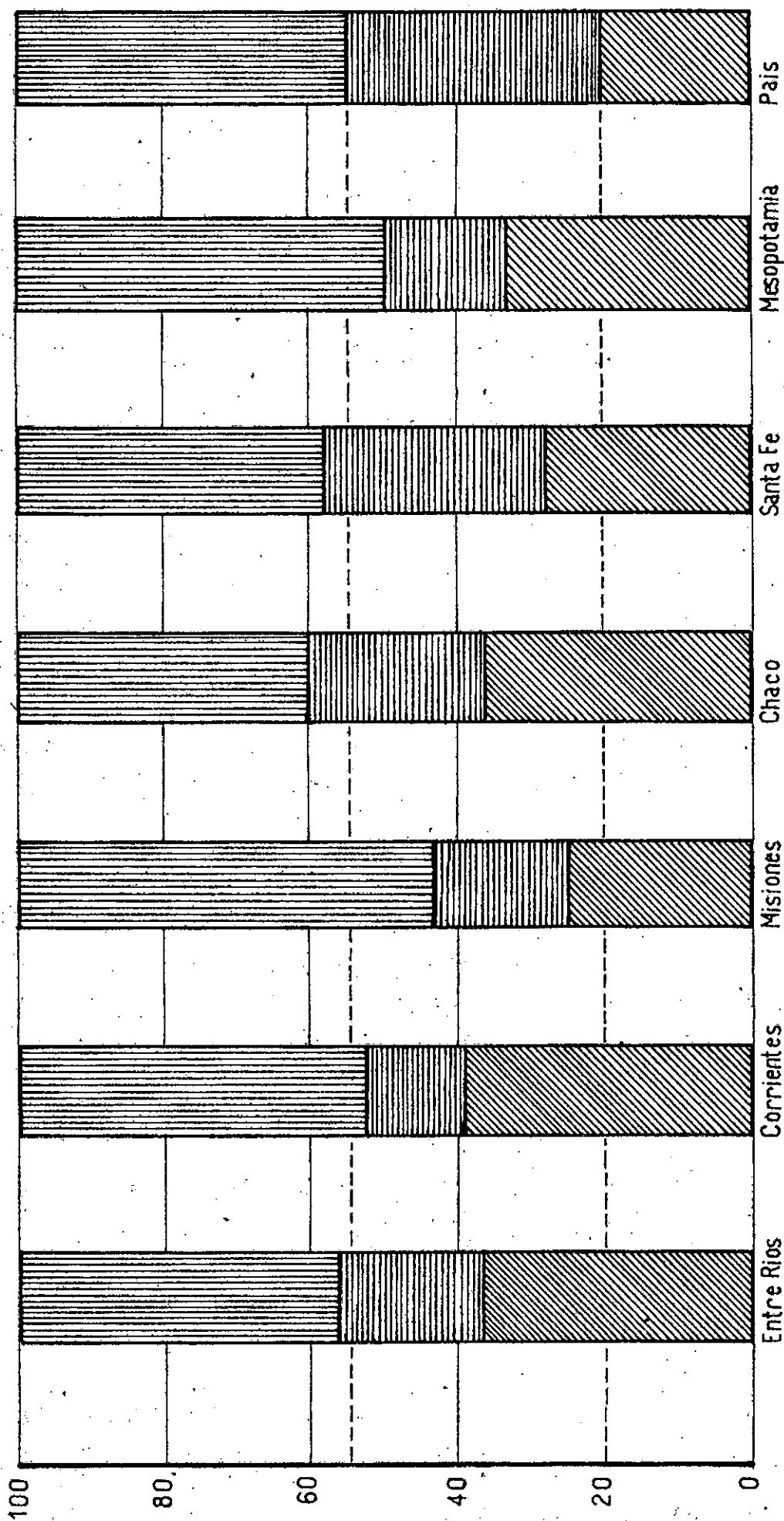

AÑO 1959

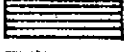

COMPOSICION DEL VALOR AGREGADO BRUTO A CF. PARA VARIAS PROVINCIAS Y EL PAIS POR GRANDES SECTORES DE ACTIVIDAD.

-  SECTOR PRIMARIO.
-  SECTOR SECUNDARIO.
-  SECTOR TERCIARIO.

ASPECTO FINANCIERO

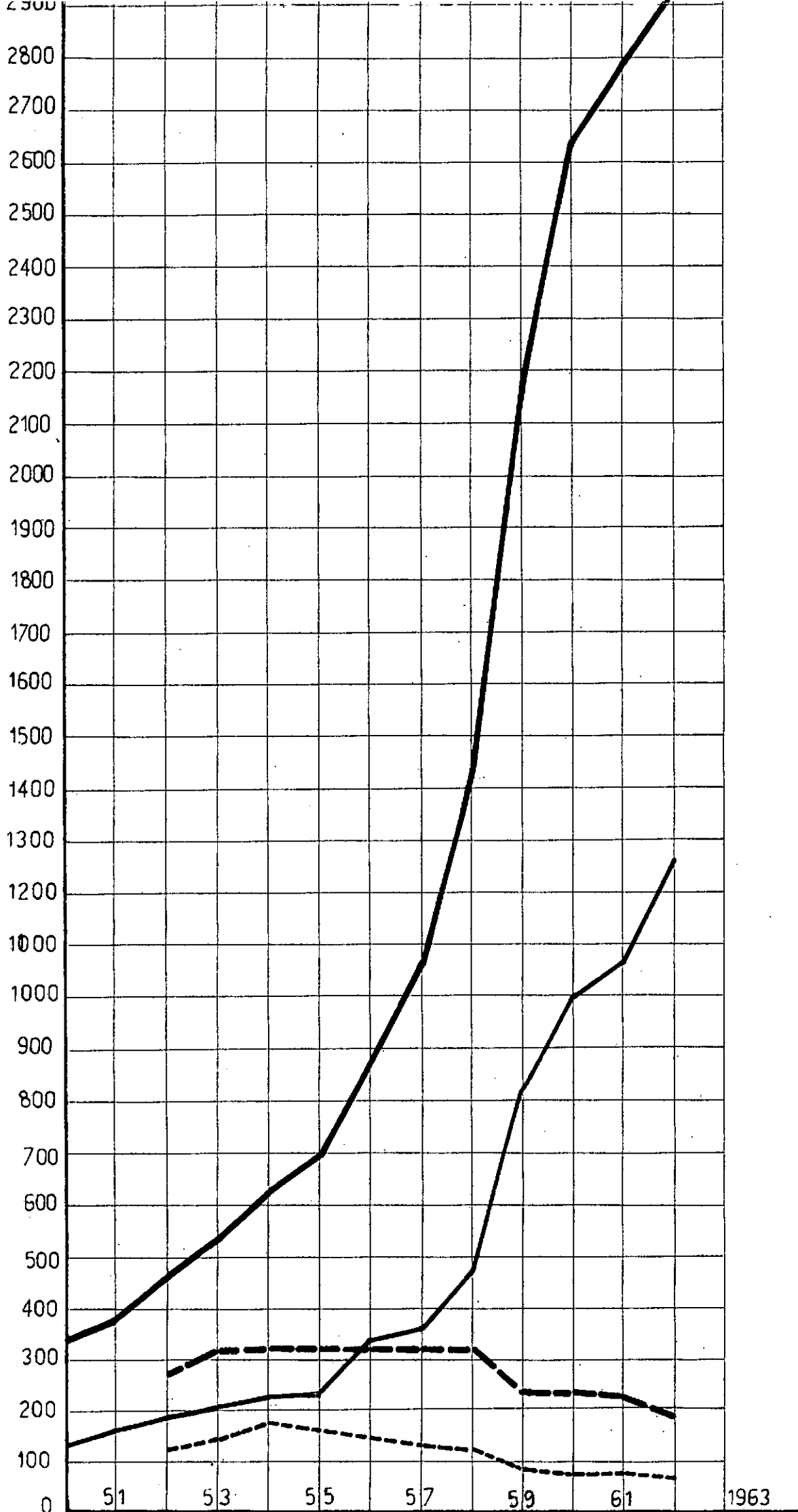

ENTRE RIOS DEPOSITOS BANCARIOS TOTALES SALDOS AL 31_12 DE CADA AÑO

- EN CTAS CTES DE PARTICULARES PESOS CORRIENTES
- - - - - PRECIOS 1950
- TOTALES EN PESOS CORRIENTES (MILLONES)
- - - - - TOTALES EN PESOS PRECIO AÑO 1950



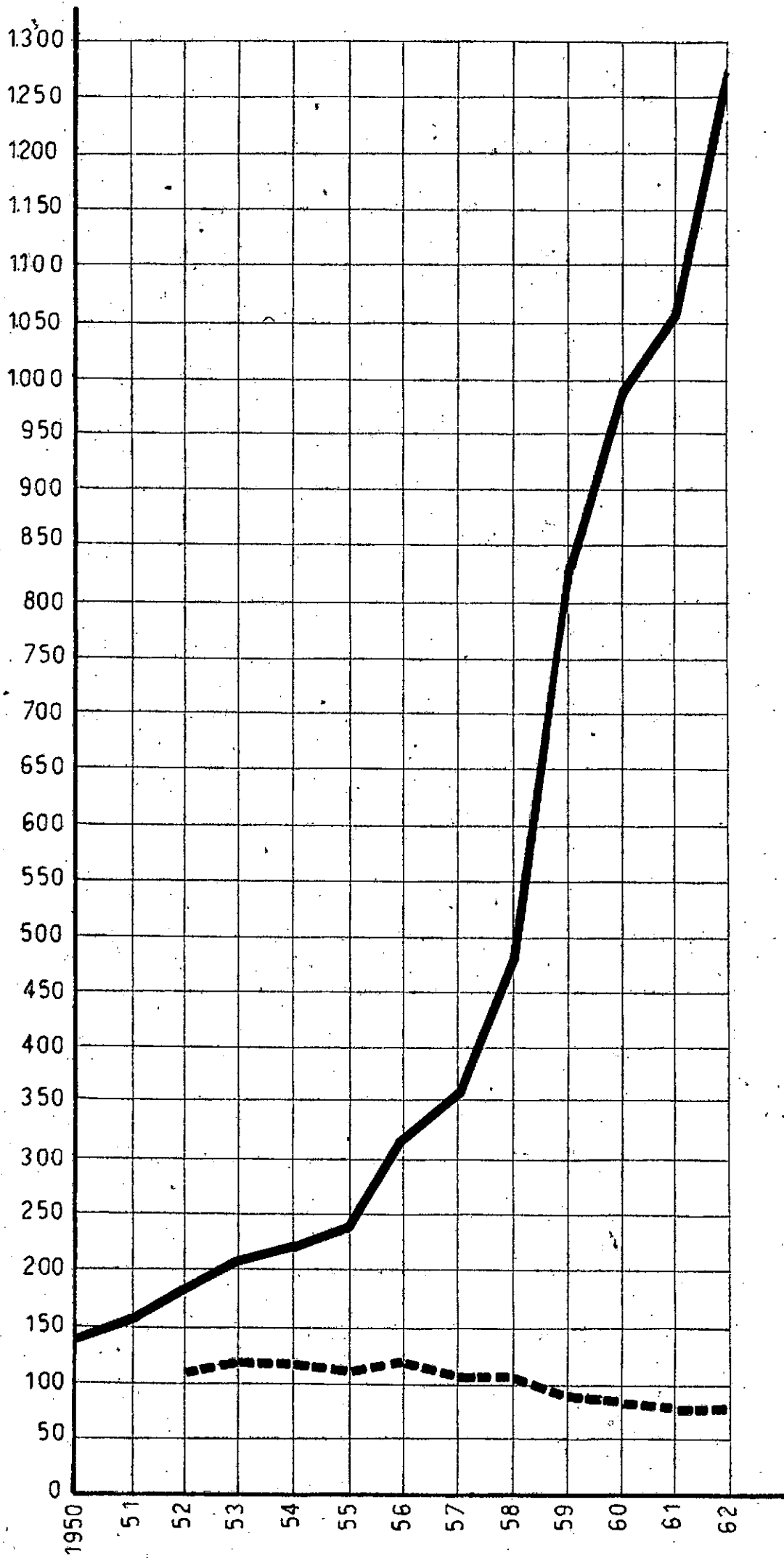



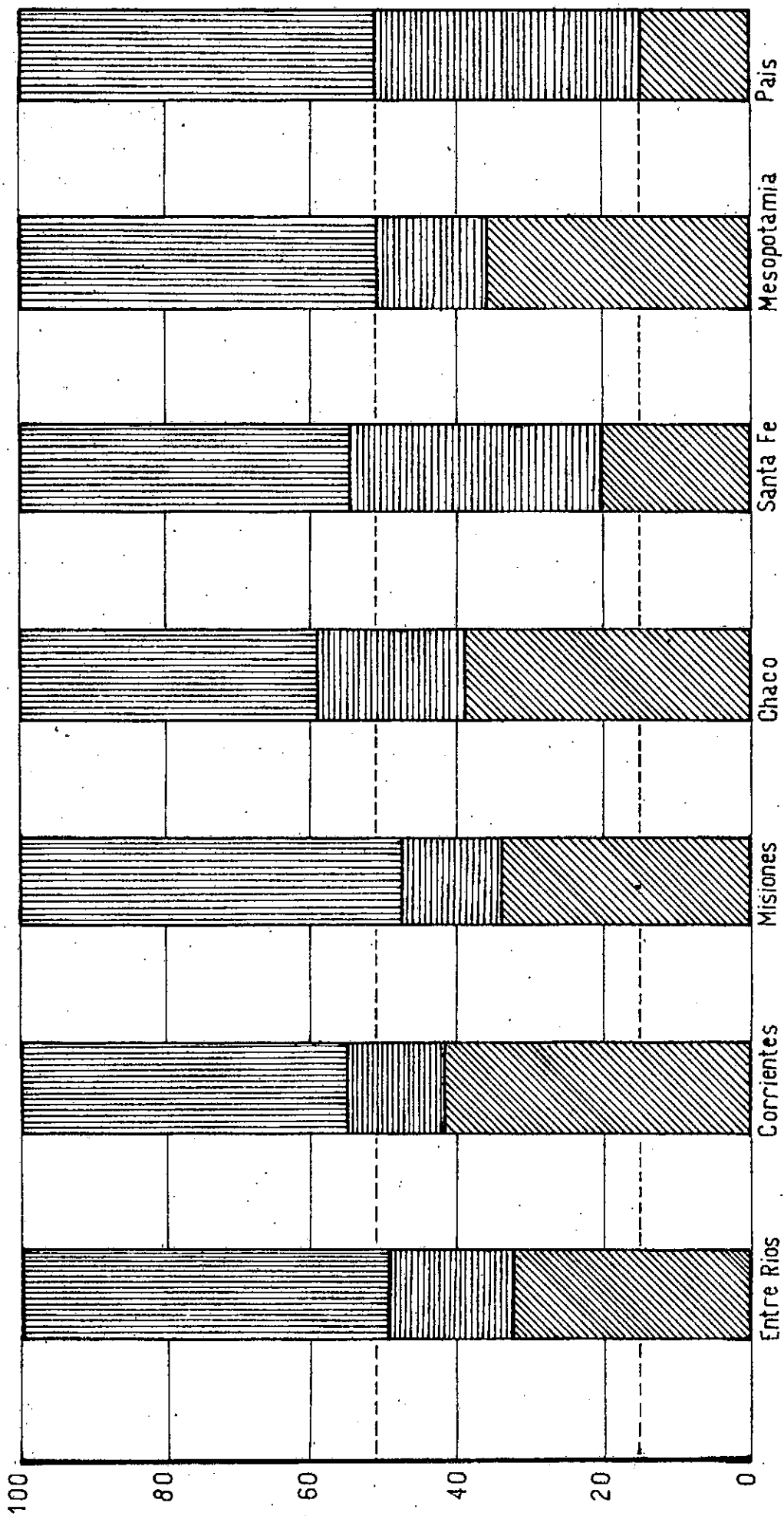

ENTRE RIOS DEPOSITOS BANCARIOS EN CUENTAS CORRIENTES DE PARTICULARES
SALDOS AL 31-12 DE CADA AÑO

— A PRECIOS CORRIENTES
- - - A PRECIOS DE 1950

AÑO 1958

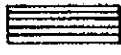

COMPOSICION DEL VALOR AGREGADO BRUTO A C.F. PARA VARIAS PROVINCIAS Y EL PAIS POR GRANDES SECTORES DE ACTIVIDAD.

-  SECTOR PRIMARIO
-  SECTOR SECUNDARIO
-  SECTOR TERCIARIO



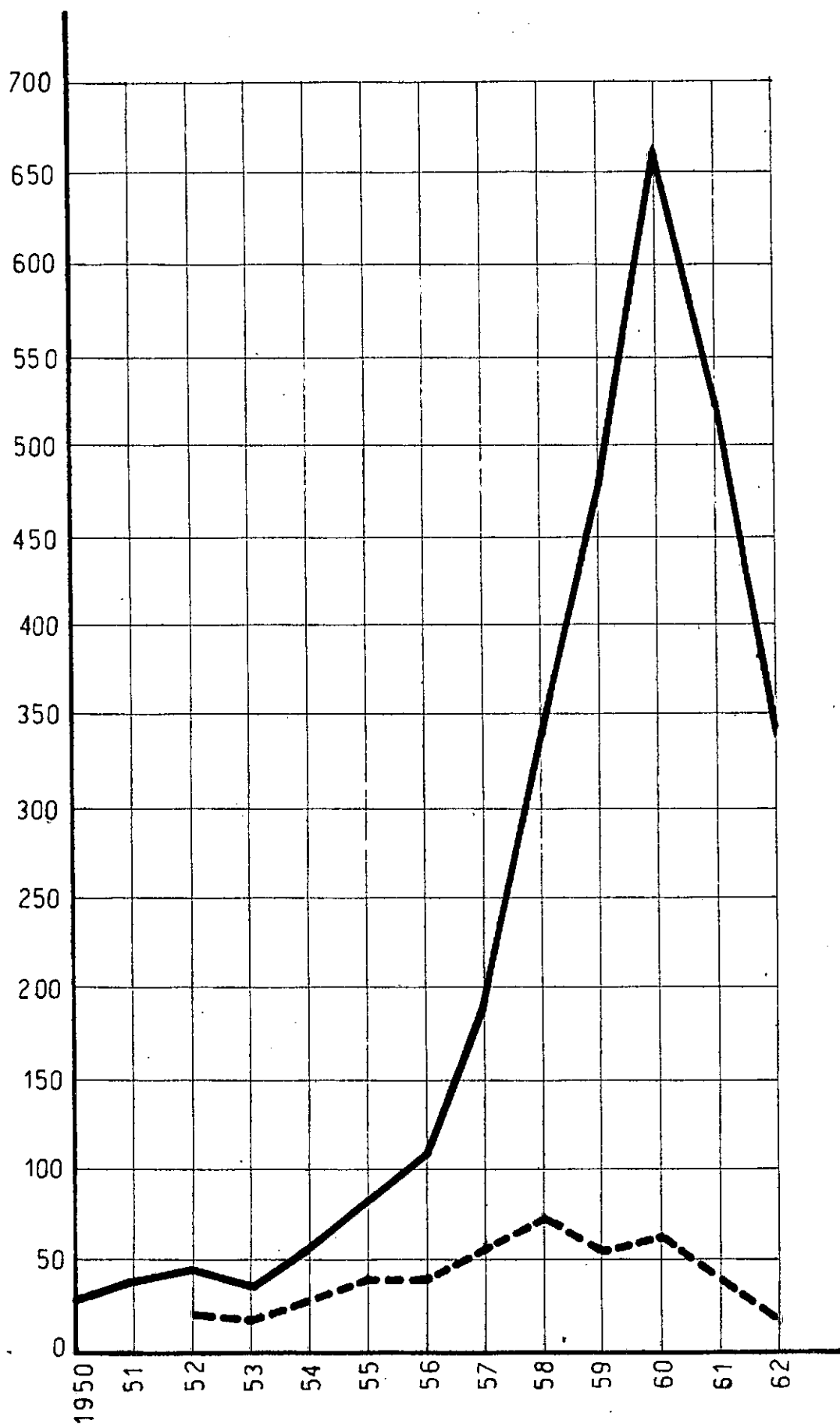

ENTRE RIOS DEPOSITOS BANCARIOS OFICIALES AL 31-12 DE CADA AÑO.

- EN PESOS CORRIENTES.
- - -** A PRECIOS 1950.

IV

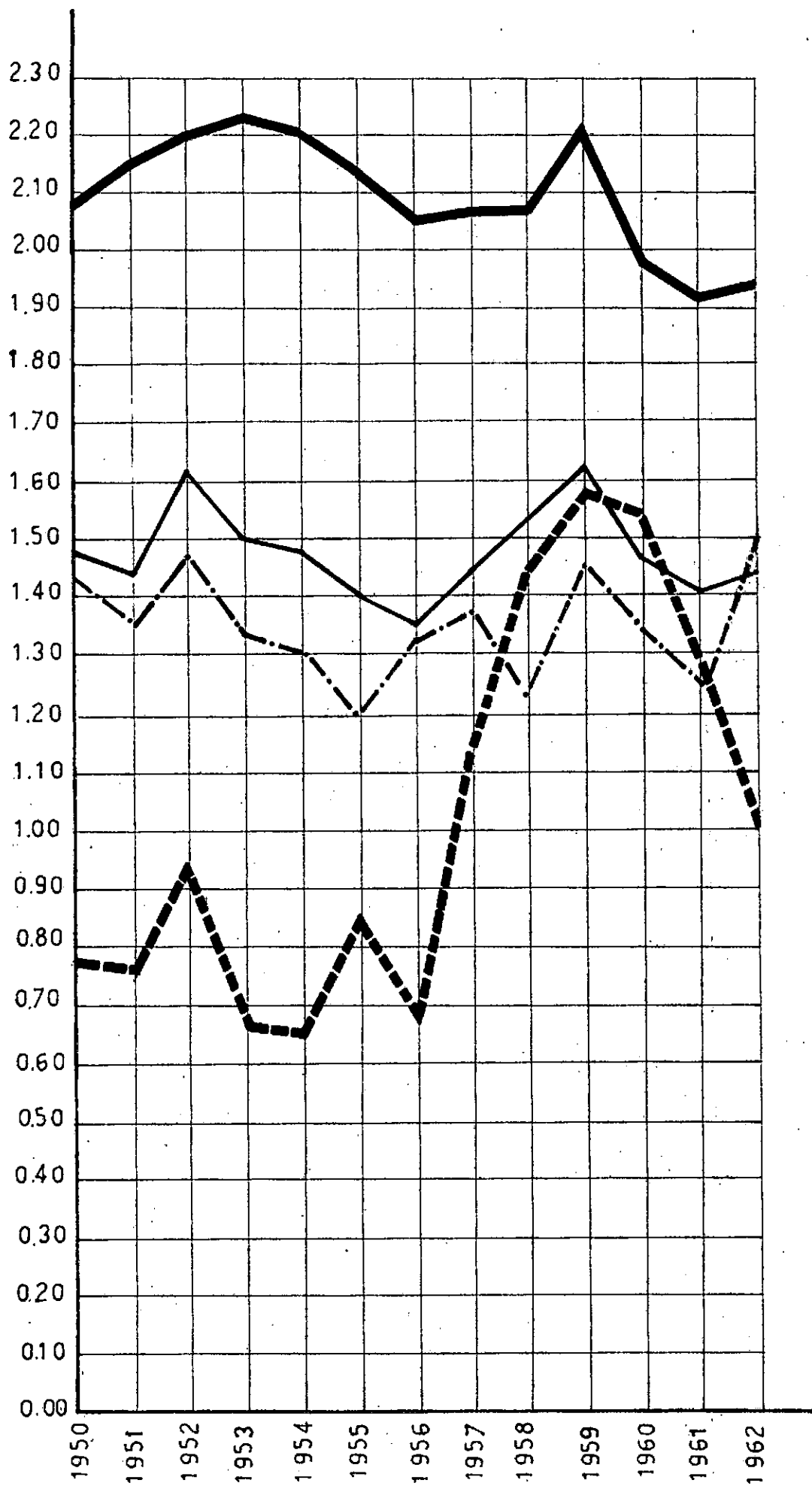

ENTRE RIOS

PORCENTAJE DE DEPOSITOS BANCARIOS RESPECTO AL PAIS,
SOBRE SALDOS AL 31-12 DE CADA AÑO

- DEPOSITOS EN CAJA DE AHORROS
- - - DEPOSITOS BANCARIOS OFICIALES
- DEPOSITOS BANCARIOS TOTALES.
- · - DEPOSITOS EN CUENTAS CORRIENTES DE PARTICULARES



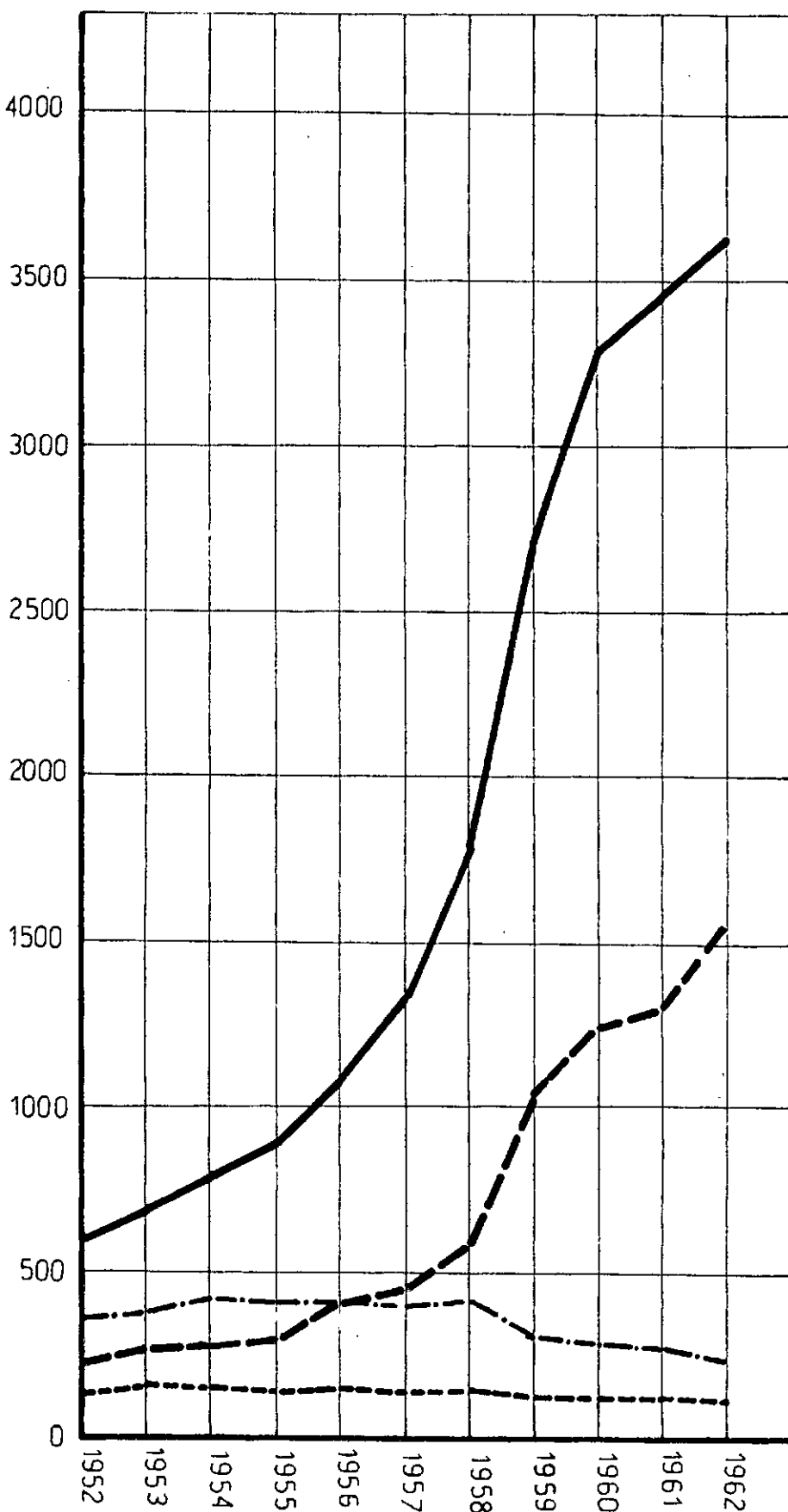

ENTRE RÍOS SALDOS DE DEPOSITOS BANCARIOS PER CAPITA (TOTALES Y CUENTAS CORRIENTES DE PARTICULARES)

- TOTALES A PRECIOS CORRIENTES
- CTAS. CTES. PARTICULARES A PRECIOS CORRIENTES
- · - · - · - TOTALES A PRECIOS 1950
- · · · · CTAS. CTES. PARTICULARES A PRECIOS 1950

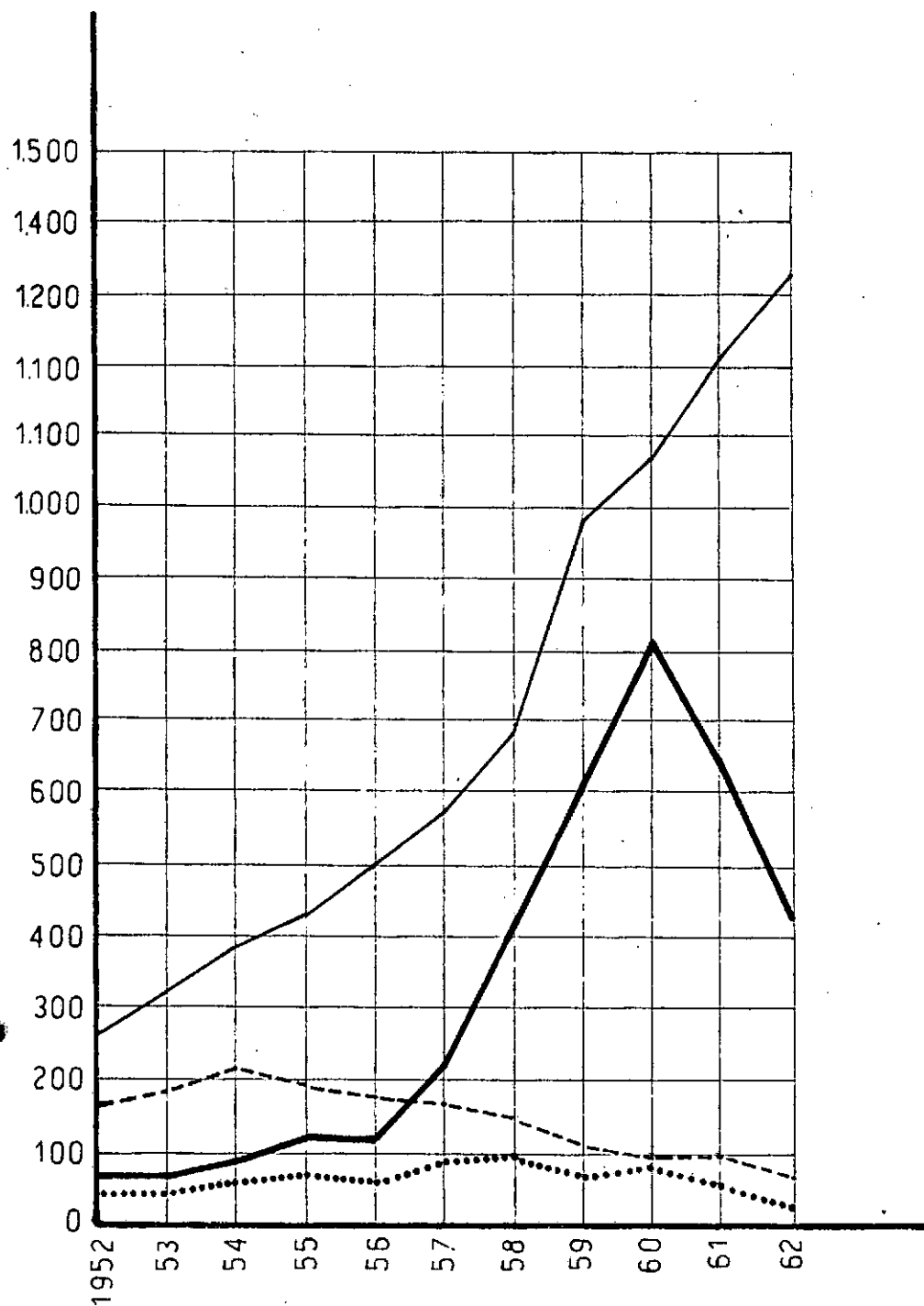

ENTRE RIOS SALDO DE DEPOSITOS BANCARIOS "PER CAPITA"
(EN CAJA DE AHORROS Y OFICIALES)

- CAJA DE AHORROS A PRECIOS CORRIENTES.
- - - - CAJA DE AHORROS A PRECIOS 1950.
- OFICIALES A PRECIOS CORRIENTES.
- OFICIALES A PRECIOS 1950

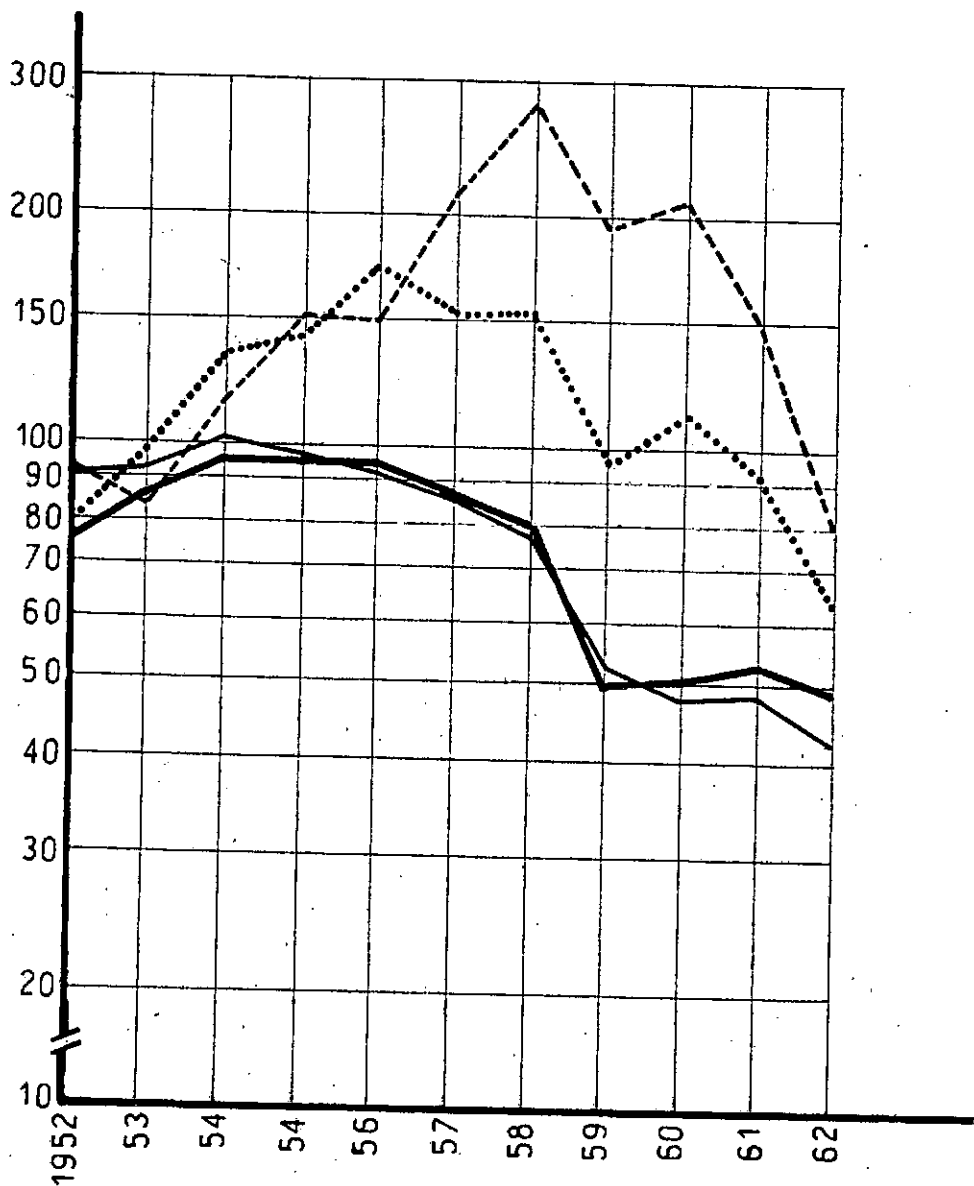

ARGENTINA

DEPOSITOS BANCARIOS EN ENTRE RIOS Y EL PAIS
A PRECIOS DE 1950 CON BASE 1950=100.

- CAJA DE AHORROS PARA ENTRE RIOS
- - - OFICIALES PARA ENTRE RIOS
- CAJA DE AHORROS PARA EL PAIS
- OFICIALES PARA EL PAIS

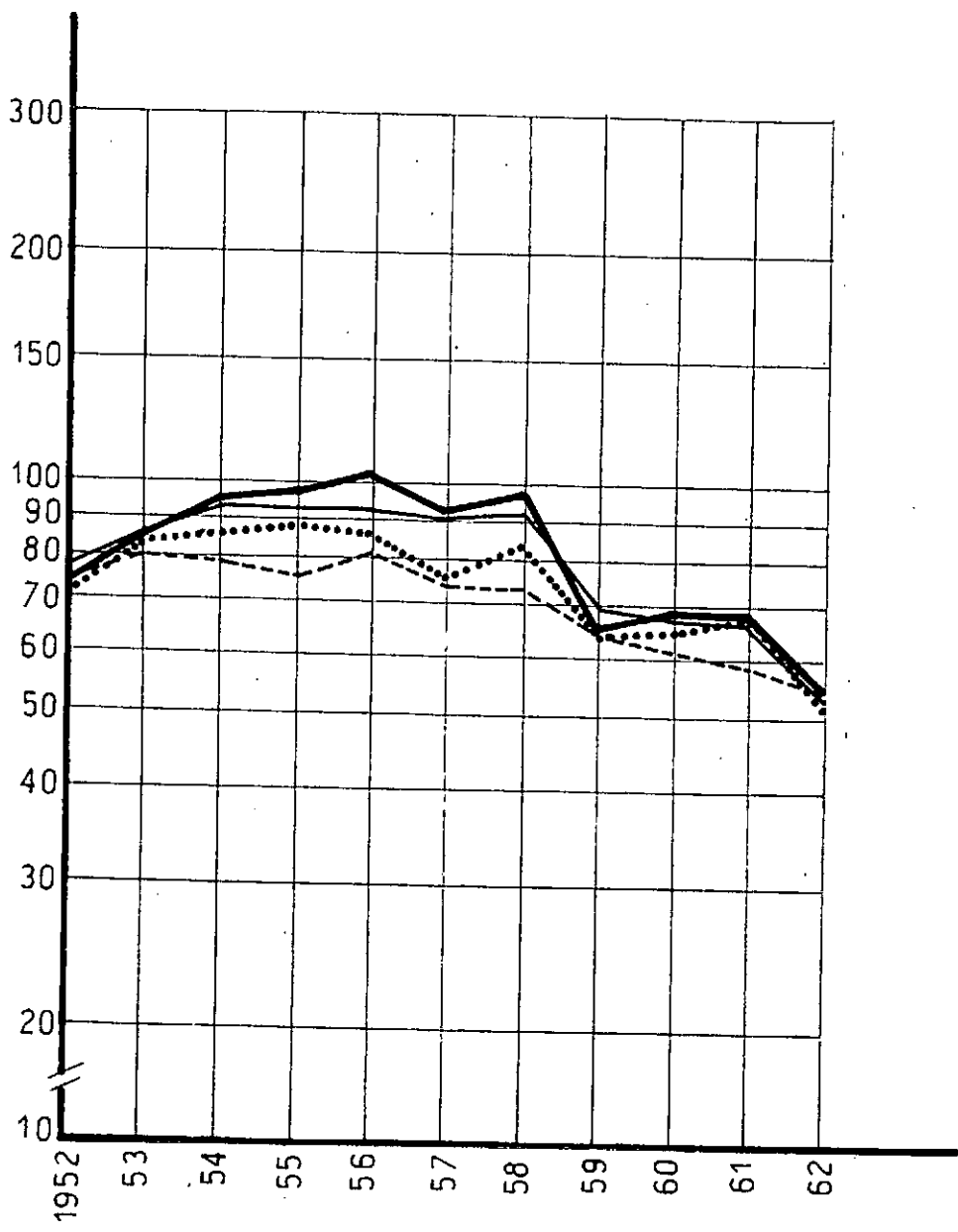

ARGENTINA DEPOSITOS BANCARIOS EN ENTRE RIOS Y EL PAIS
A PRECIOS DE 1950 CON BASE 1950=100

- TOTALES PARA ENTRE RIOS.
- CTAS. CTES. PARTICULARES PARA ENTRE RIOS.
- TOTALES PARA EL PAIS.
- CTAS. CTES. PARTICULARES PARA EL PAIS.

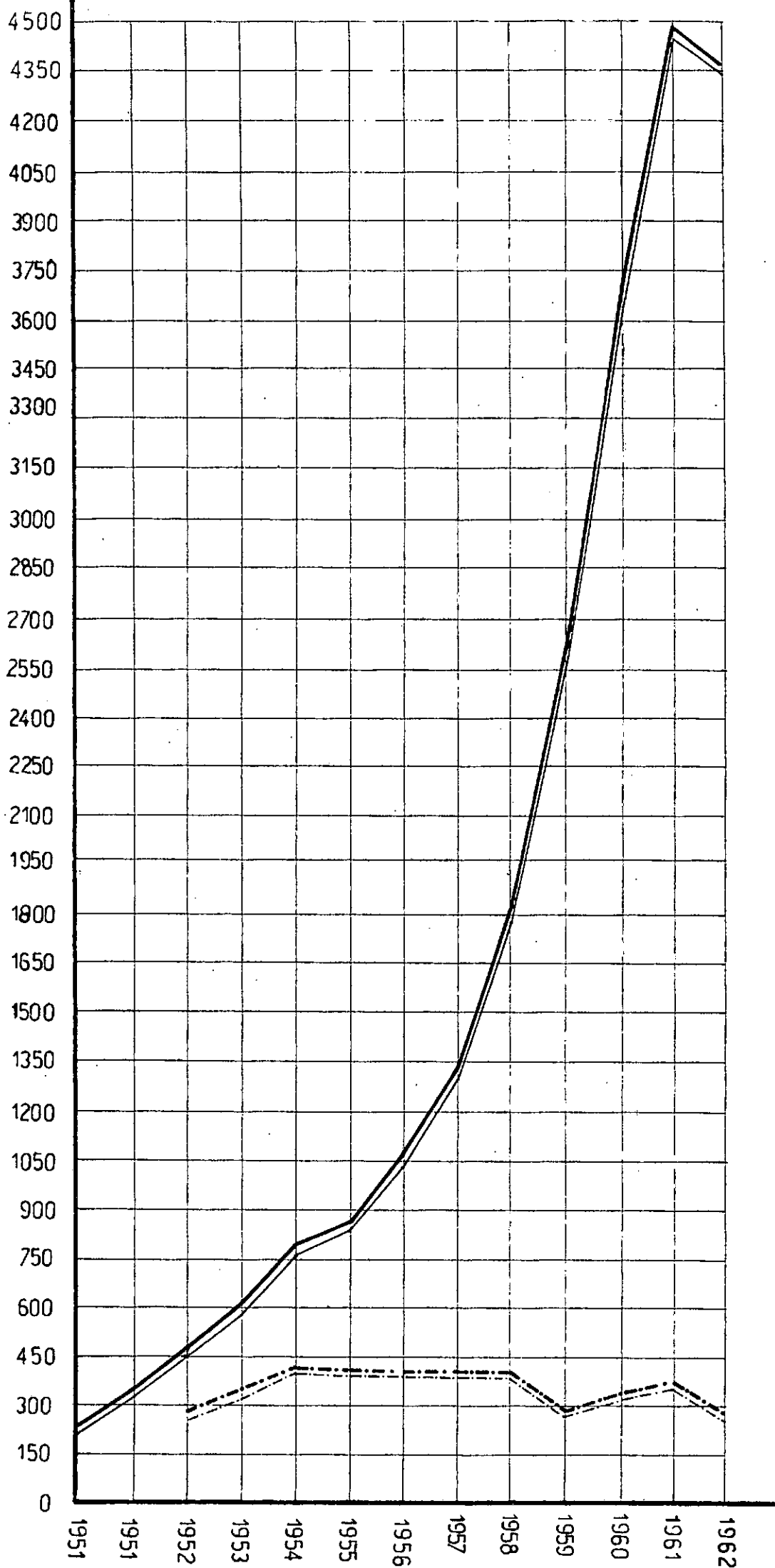

ENTRE RIOS PRESTAMOS BANCARIOS TOTAL Y AL PUBLICO
SALDOS AL 31-12 DE CADA AÑO.

- PRESTAMOS TOTALES PRECIOS CORRIENTES
- - - - PRESTAMOS TOTALES PRECIOS 1950
- PRESTAMOS AL PUBLICO PRECIOS CORRIENTES
- - - - PRESTAMOS AL PUBLICO PRECIOS 1950



dic. 1963

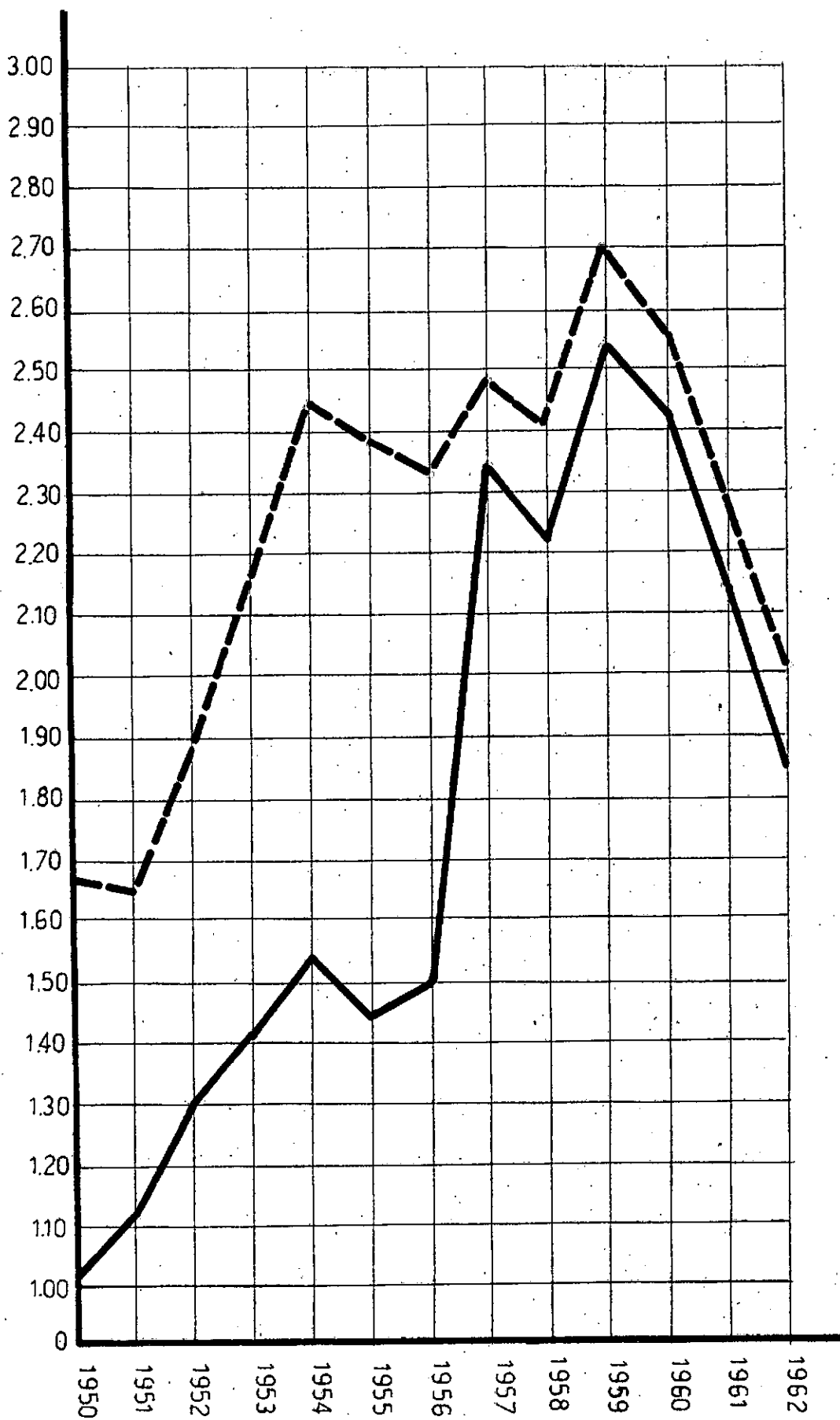

ENTRE RIOS PORCENTAJE DE PRESTAMOS BANCARIOS TOTAL Y AL PUBLICO RESPECTO AL PAIS

——— PRESTAMOS BANC. TOTAL
 - - - - - PRESTAMOS BANC. PUBLICO

XI

dic. 1963

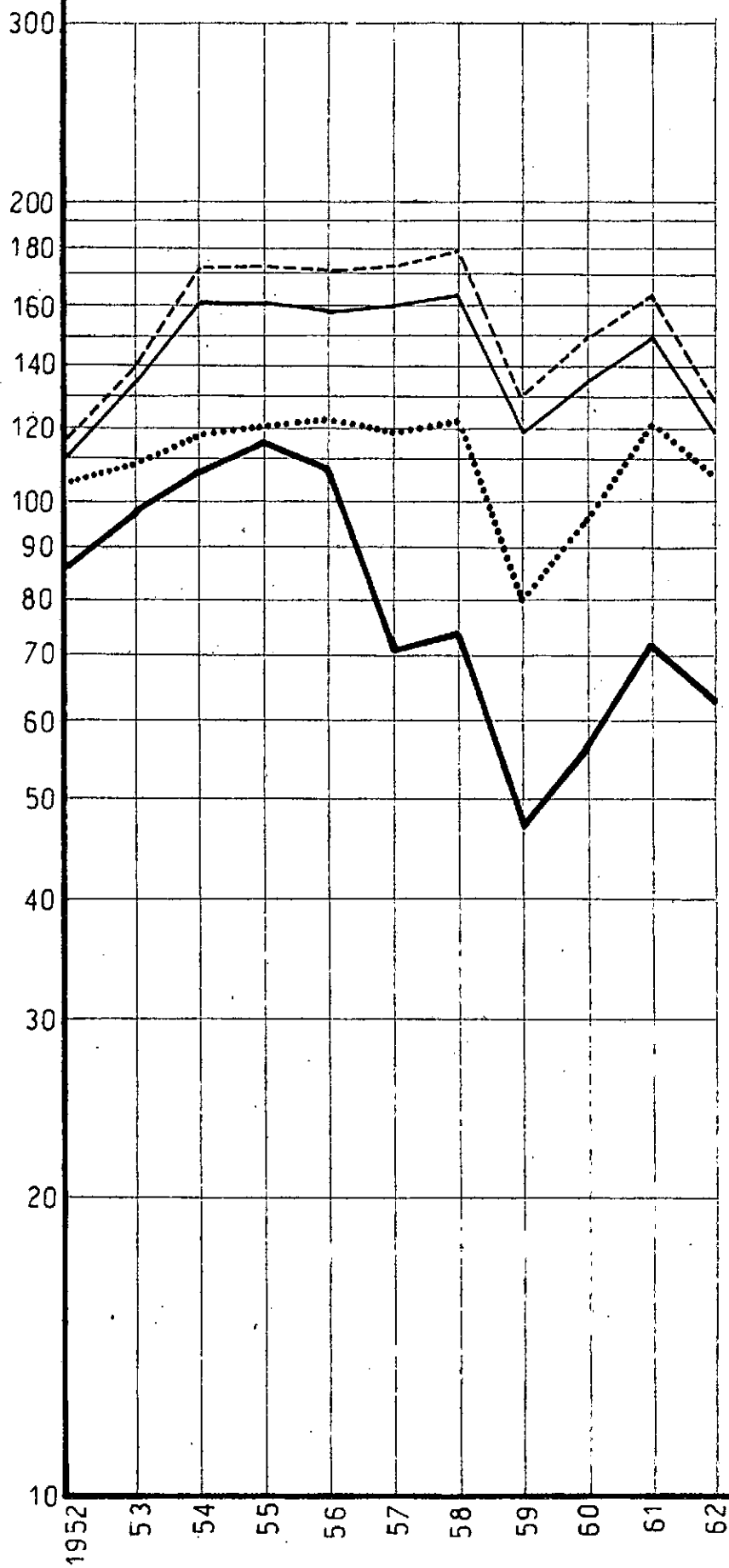

ARGENTINA

PRESTAMOS BANCARIOS PARA ENTRE RIOS Y EL PAIS A PRECIOS DE 1950
 INDICE BASE 1950 = 100

- TOTALES PARA ENTRE RIOS
- AL PUBLICO PARA ENTRE RIOS
- TOTALES PARA EL PAIS
- AL PUBLICO PARA EL PAIS

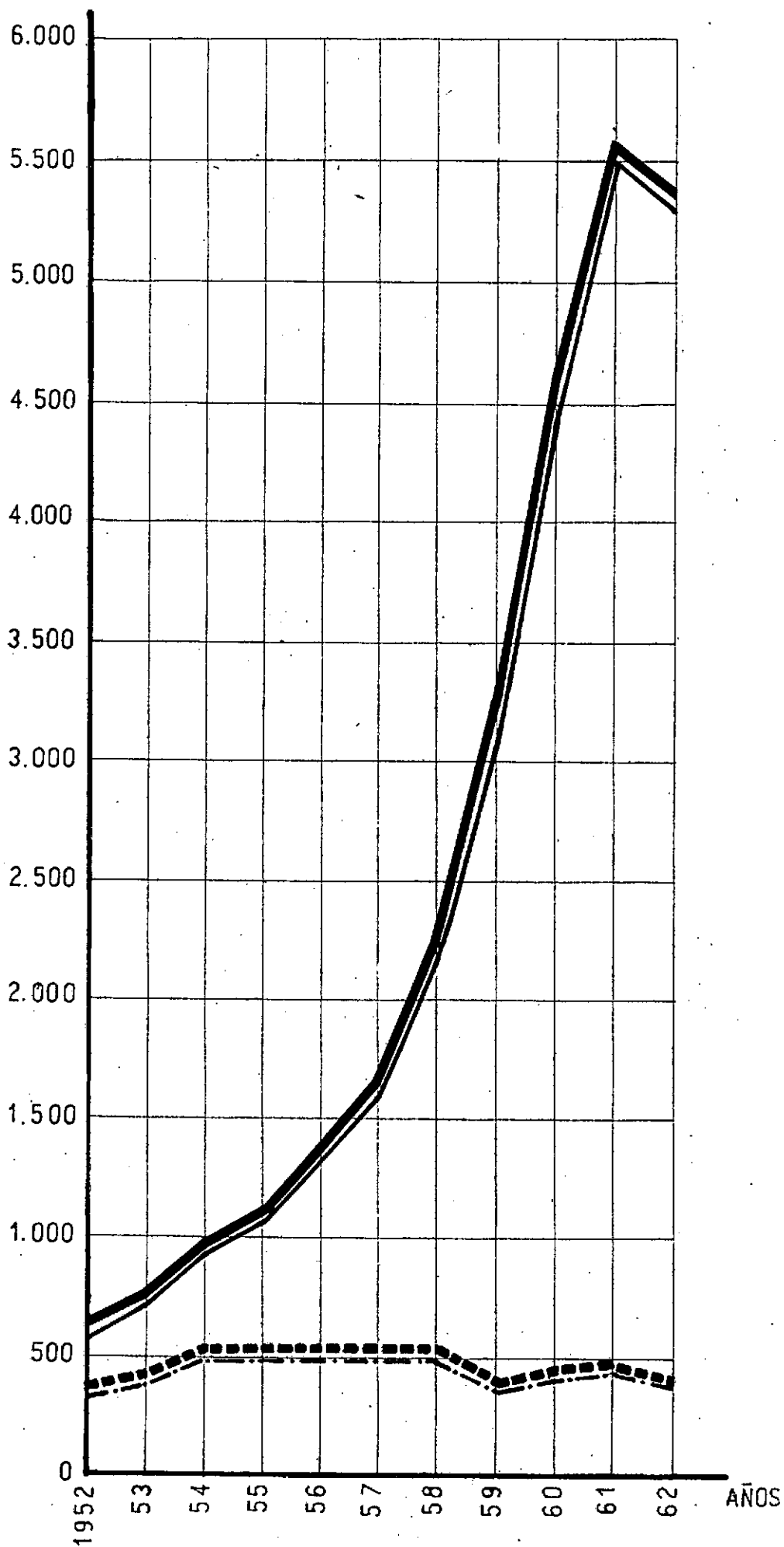

ENTRE RIOS SALDOS DE PRESTAMOS BANCARIOS "PER CAPITA" (TOTALES Y AL PUBLICO).

- TOTALES A PRECIOS CORRIENTES.
- - - TOTALES A PRECIOS 1950.
- AL PUBLICO A PRECIOS CORRIENTES.
- - - AL PUBLICO A PRECIOS 1950.

XIII

dic. 1963

AVICOLAS

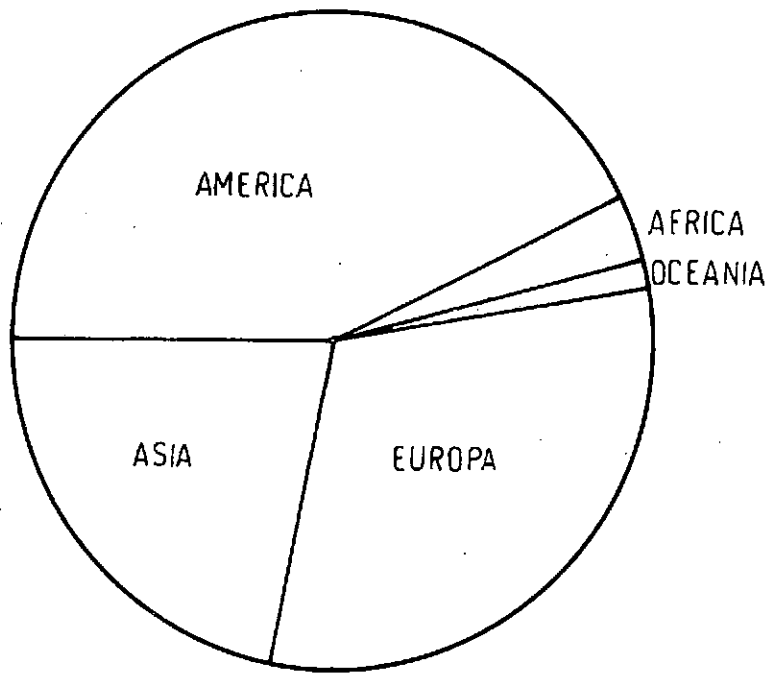

PRODUCCION MUNDIAL DE HUEVOS.

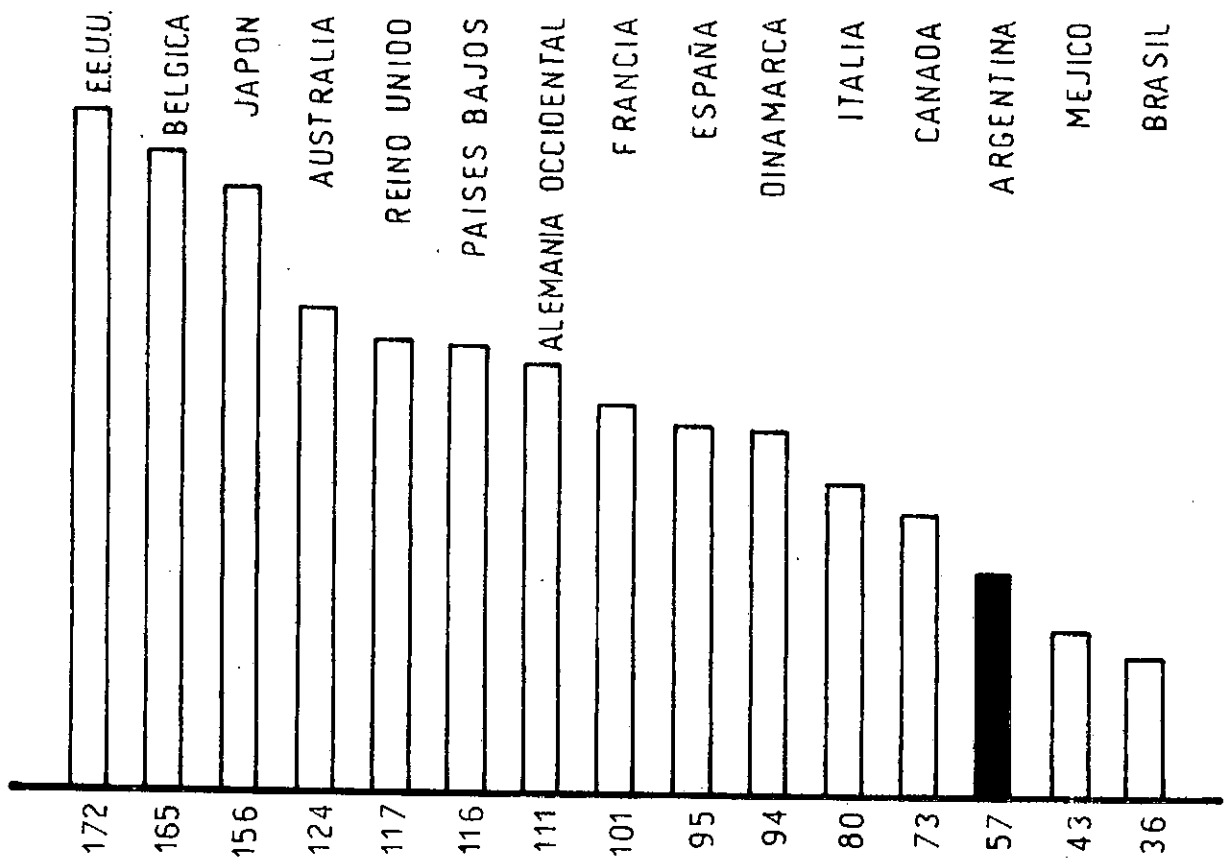

INDICE DE POSTURA POR AVE - POR AÑO

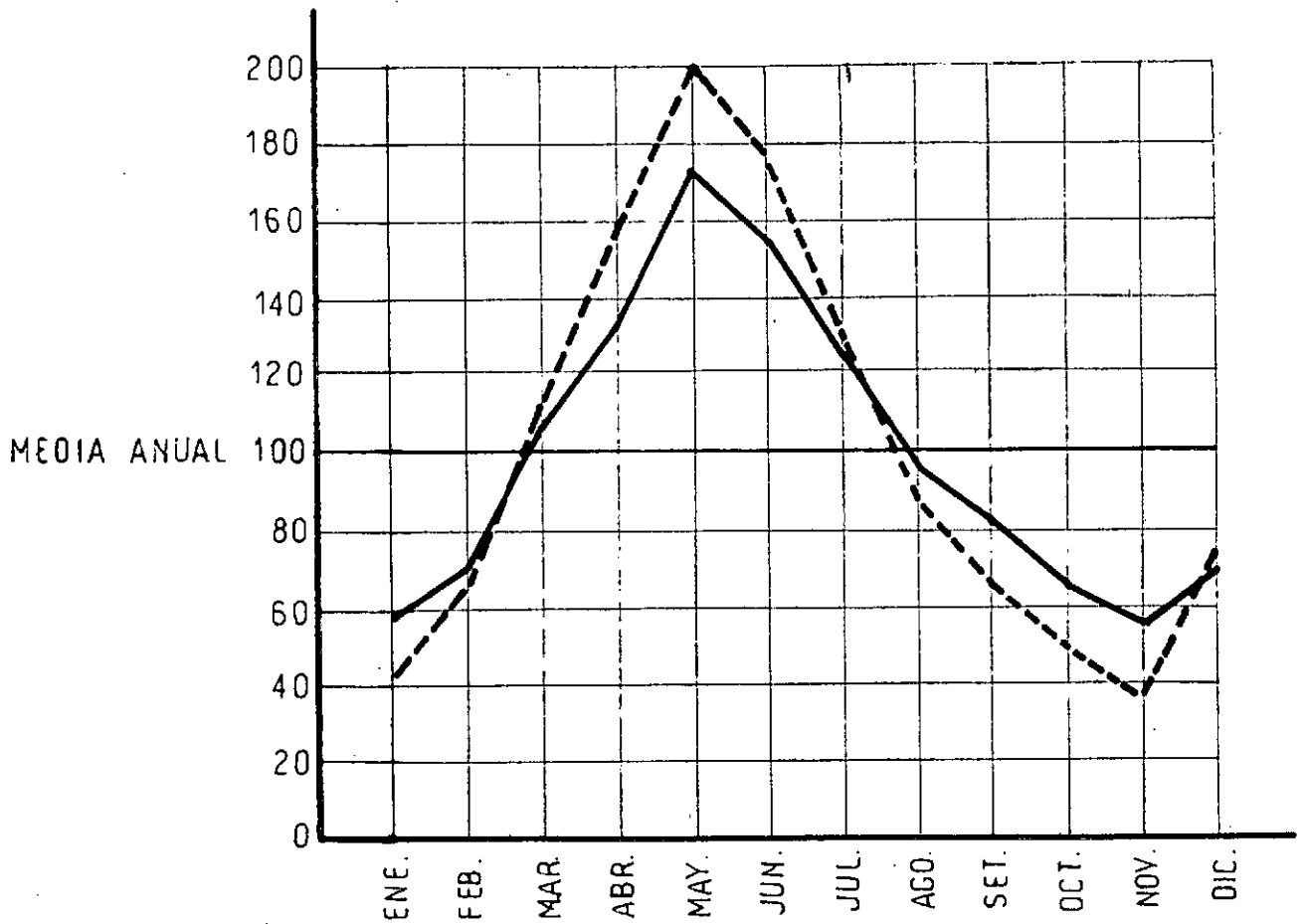

ARGENTINA OSCILACIONES ANUALES EN FAENAMIENTO DE POLLOS Y GALLINAS

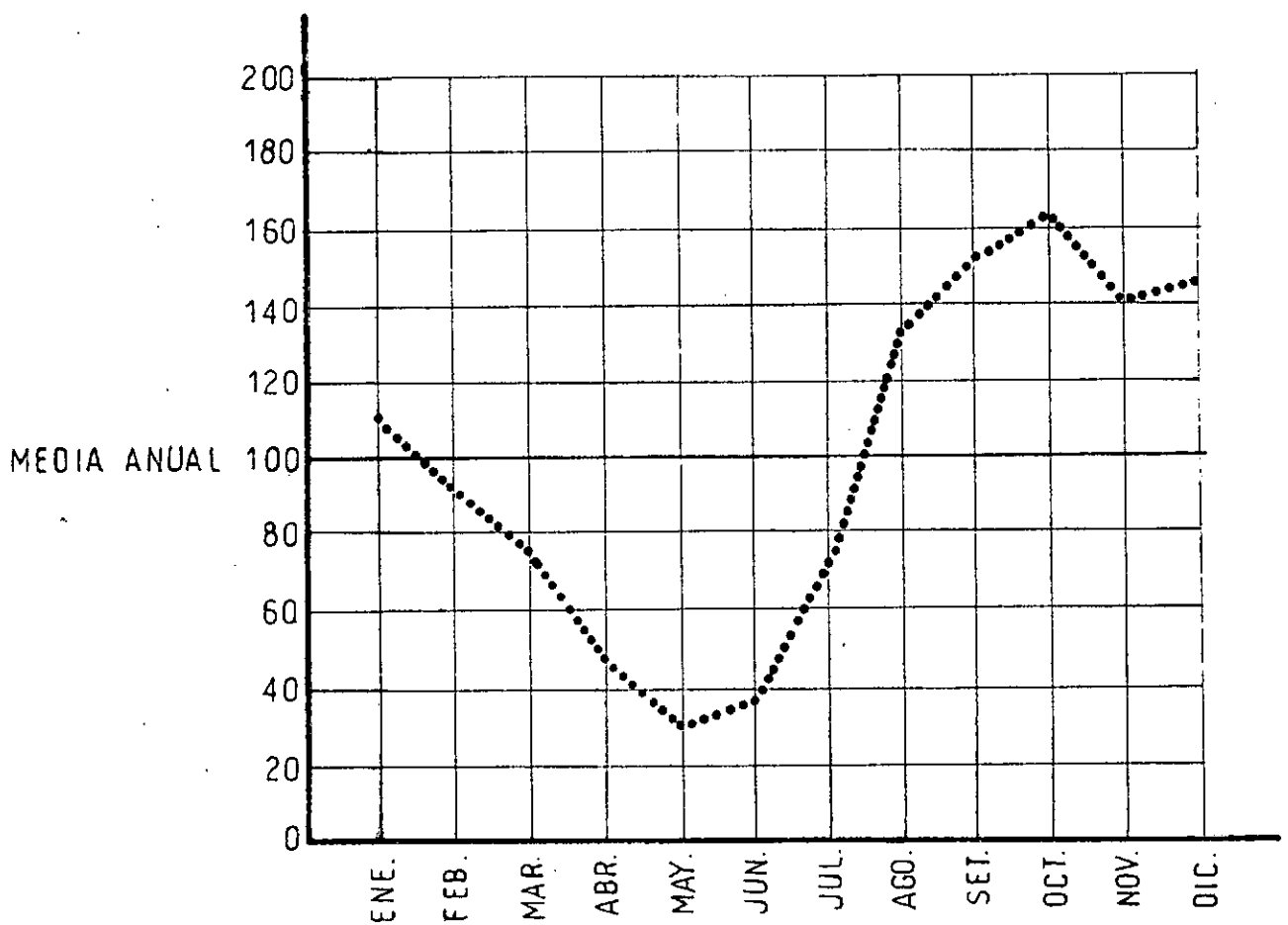

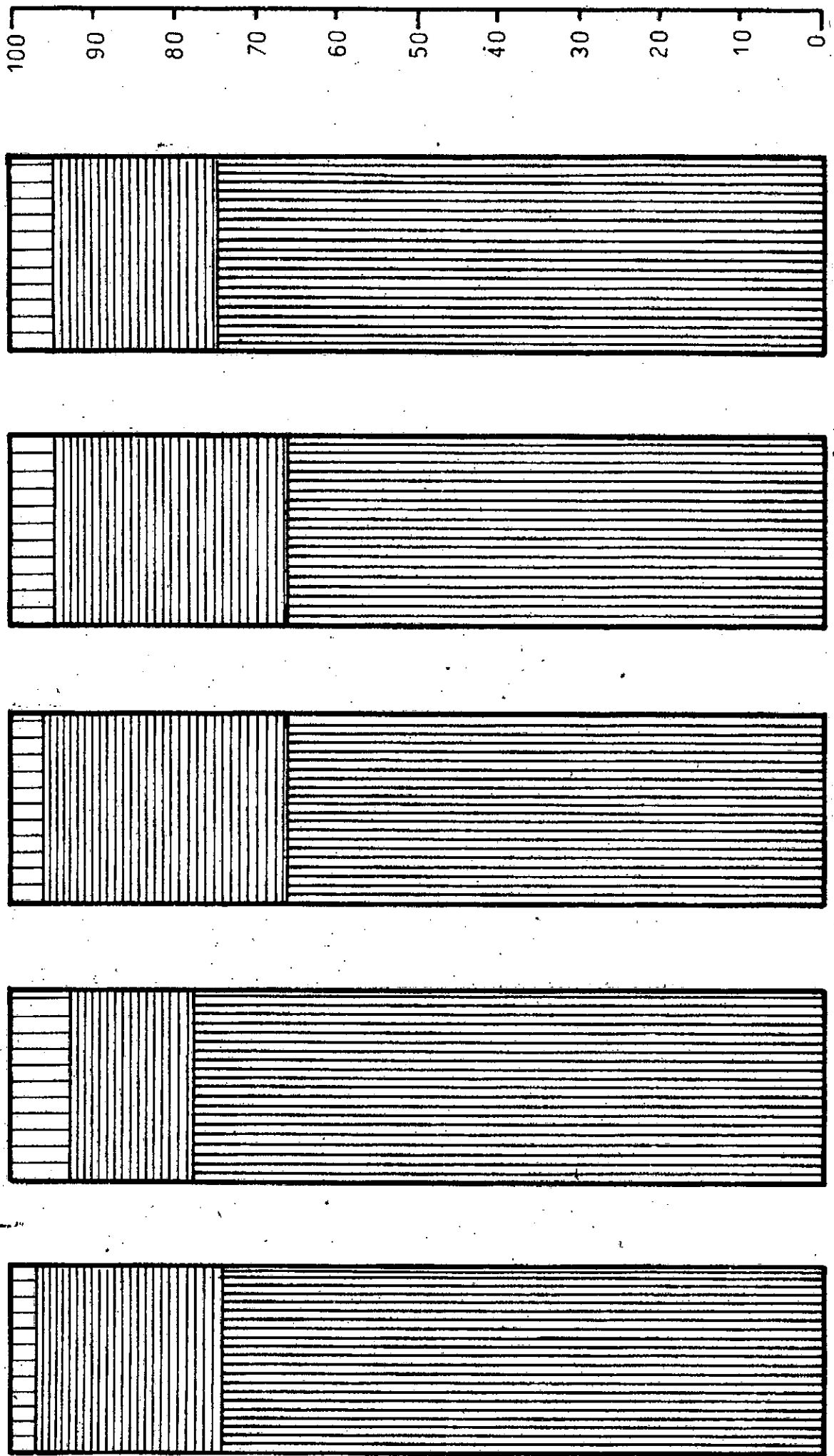

ARGENTINA OSCILACIONES ANUALES EN PRODUCCION DE HUEVOS.

- POLLOS
- - - GALLINAS

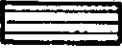

ARGENTINA COMPOSICION DE LA EXPORTACION DE PRODUCTOS AVICOLAS. (EN %)

-  HUEVOS
-  AVES
-  OTROS PRODUCTOS

G. 5

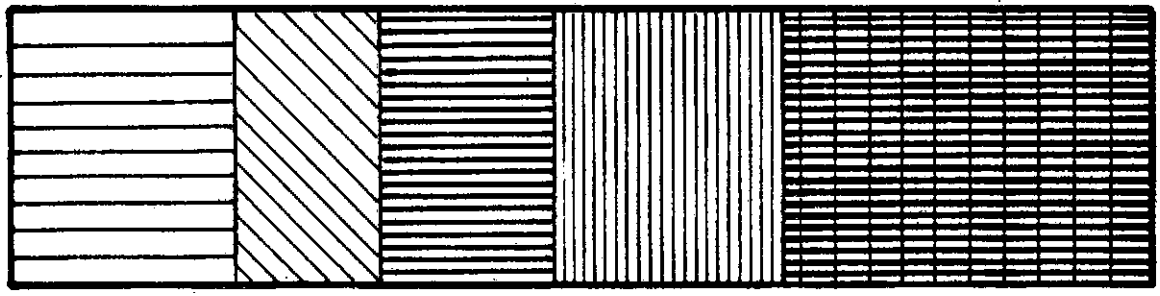
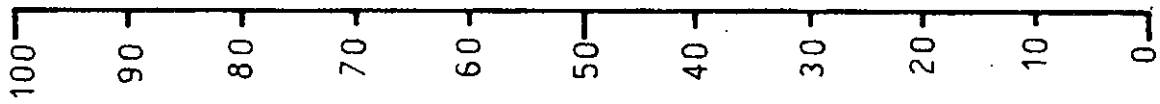

1960

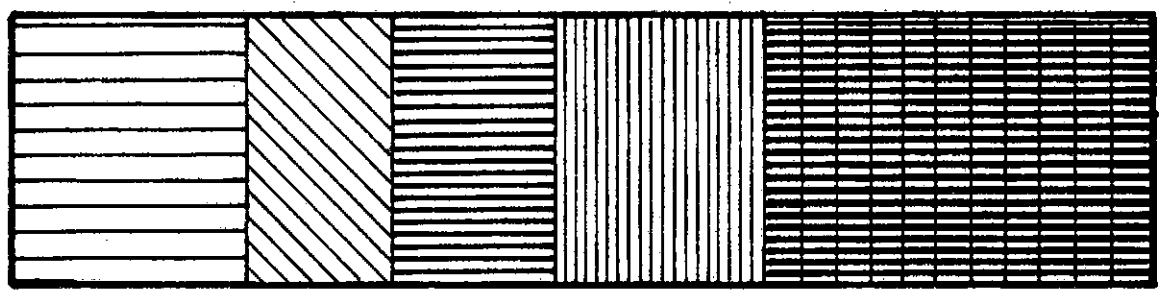

1952

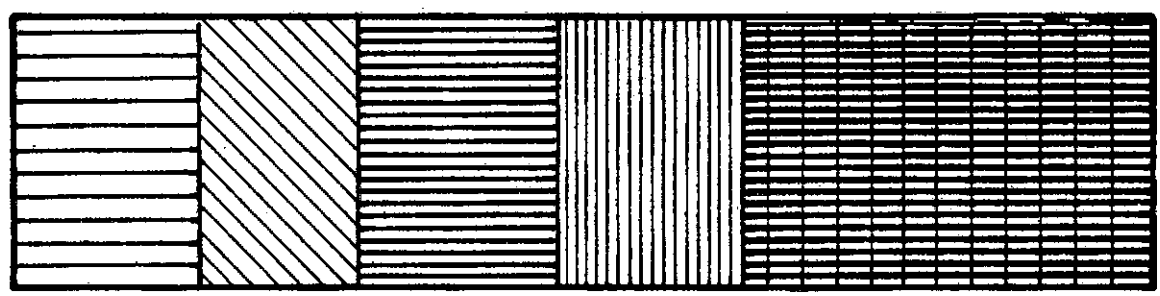

1947

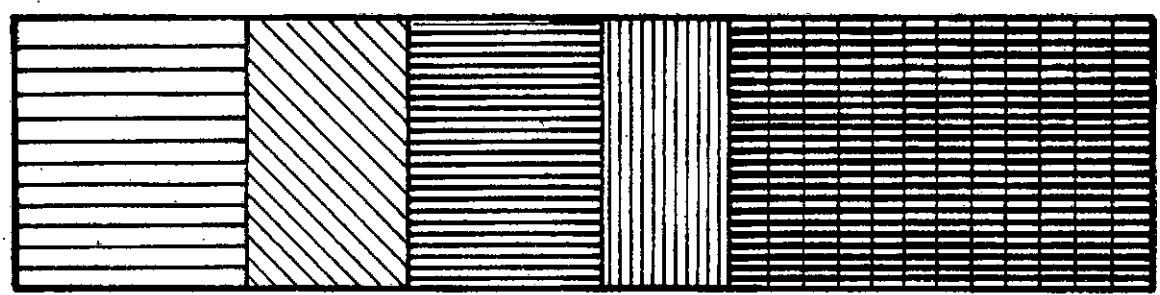

1937

ARGENTINA DISTRIBUCION DE LA POBLACION AVICOLA. (EN %)

-  BUENOS AIRES
-  CORDOBA
-  ENTRE RIOS
-  RESTO DEL PAIS
-  SANTA FE

G. 6

dic.1963

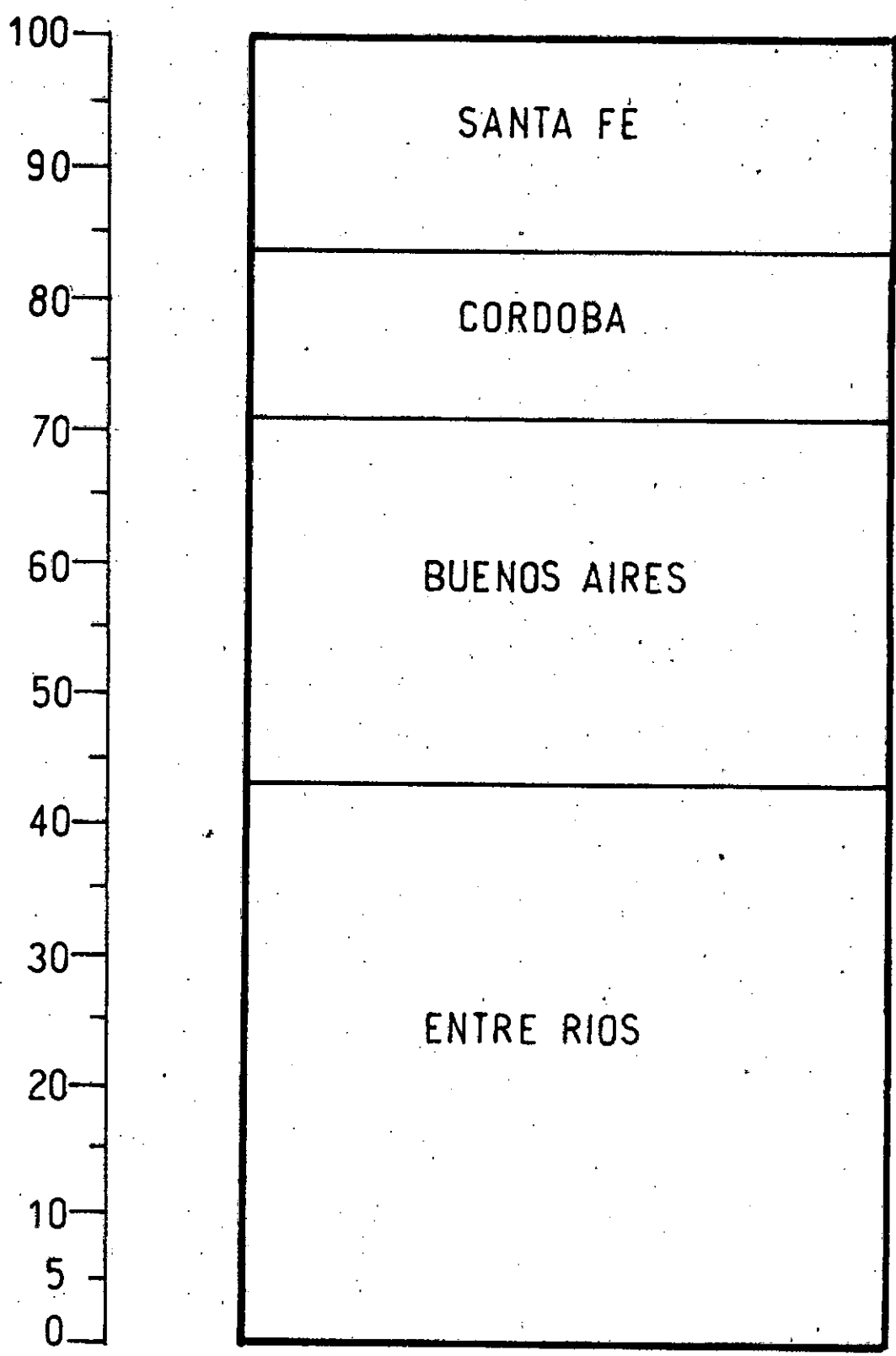

ARGENTINA PRODUCCION DE HUEVOS (EN %).-AÑO 1960

Apendice:

POSSIBILIDADES DE DESARROLLO AVICOLA EN
LA PROVINCIA DE ENTRE RIOS

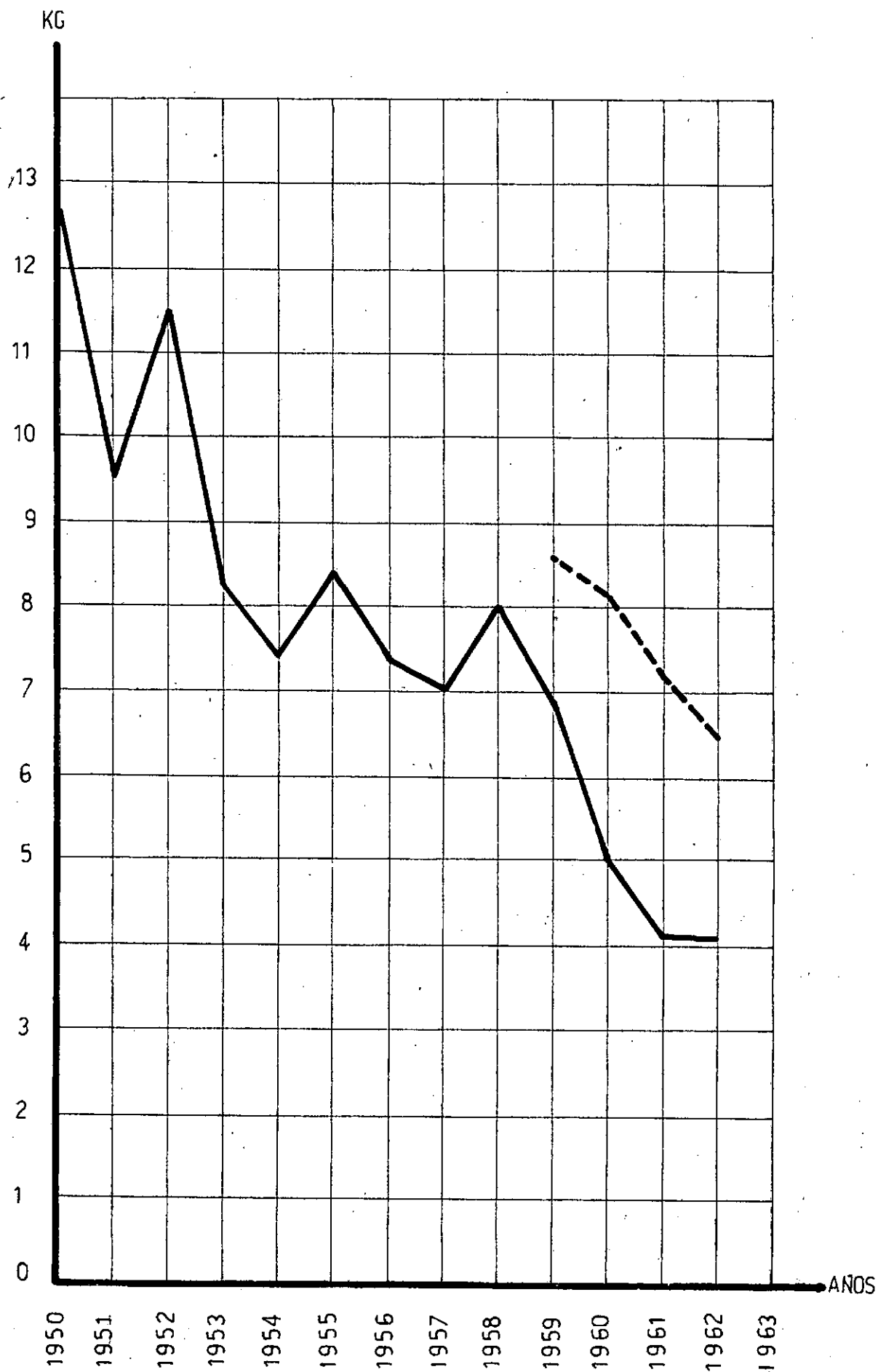

ARGENTINA PODER ADQUISITIVO DEL AVICULTOR

— KG ALIMENTO POR DOC. HUEVOS

- - - KG. ALIMENTO POR KG. AVE

G.8

dic. 1963